

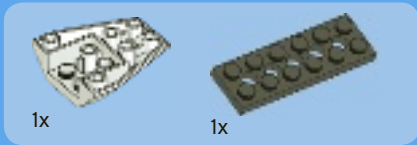

CREATOR

5770

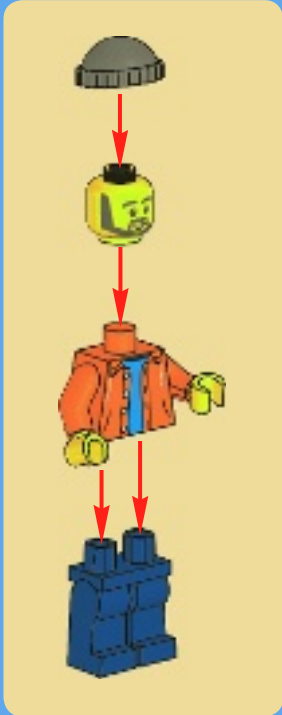



1

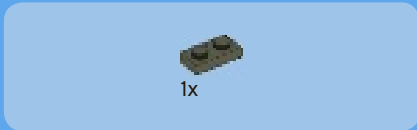
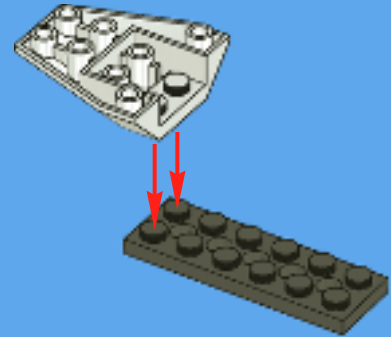

2

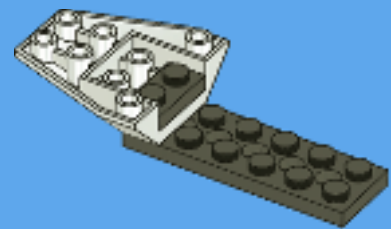



1x

3

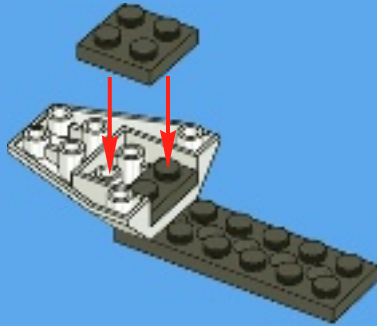

6x

4

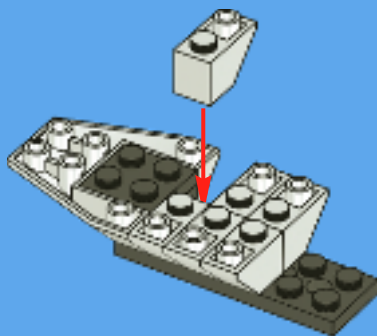

1x



1x



1x



1x



1x

5

1

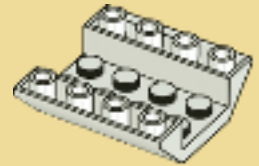

2

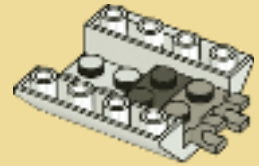

3

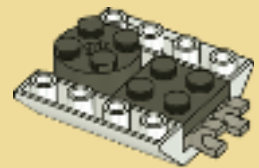



6

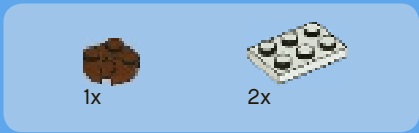
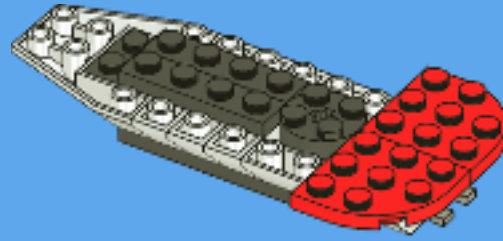

7

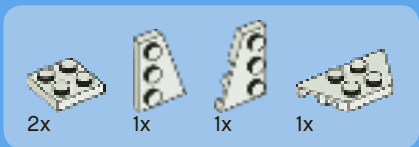
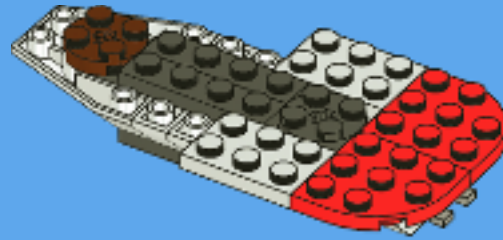

8

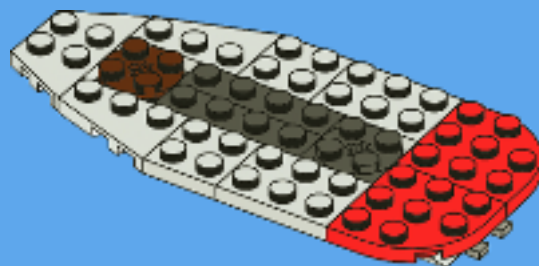



2x



2x

9

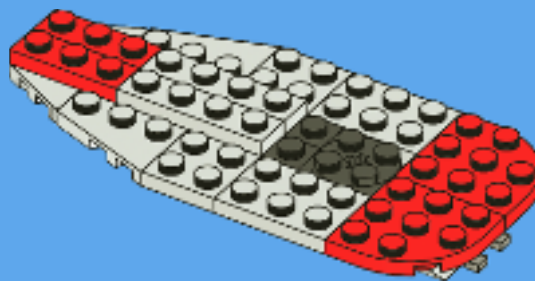

2x



2x



2x

10

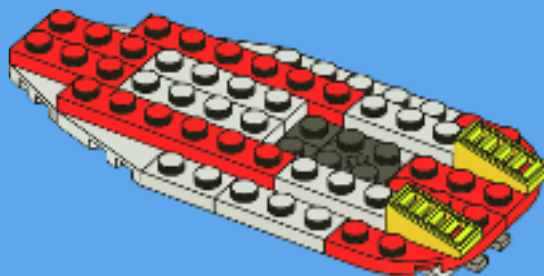

2x



2x

11

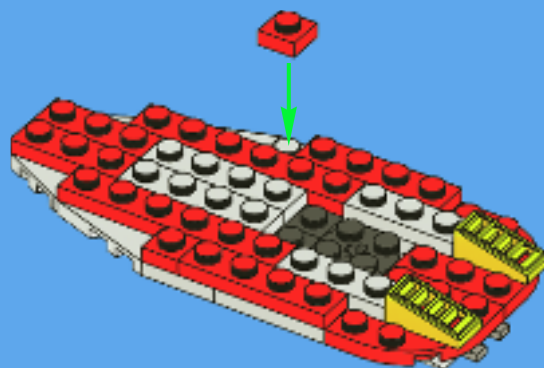



1x



2x

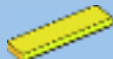

2x

12

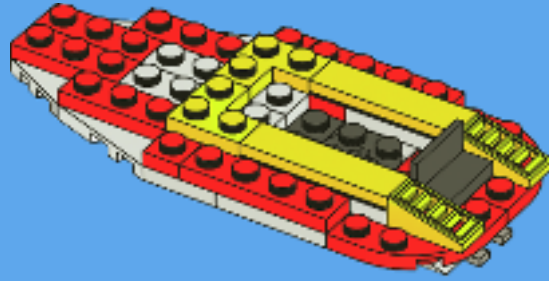

2x



2x



1x



1x



1x

13

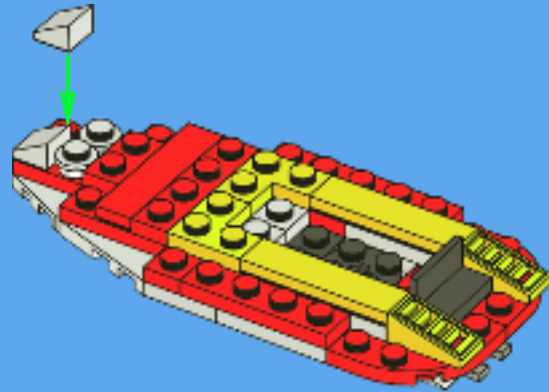

1x



2x



2x

14

1



2

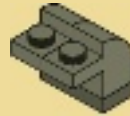

3

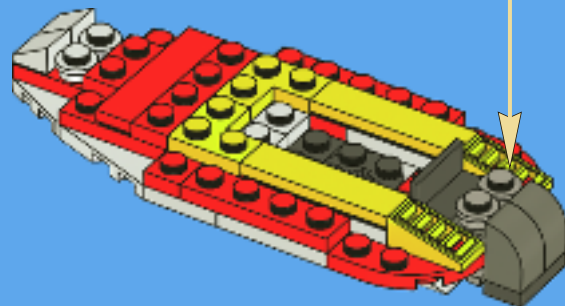
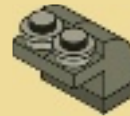

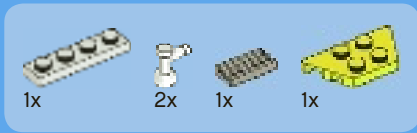

15

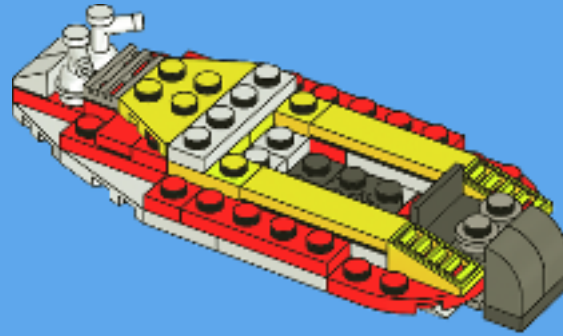

16

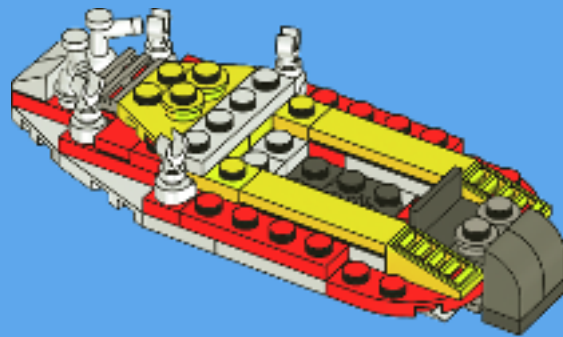

17

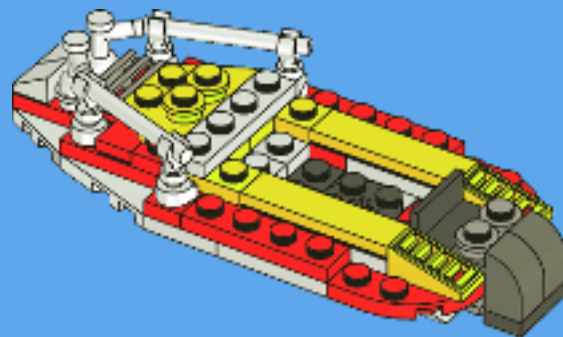



2x



2x

18

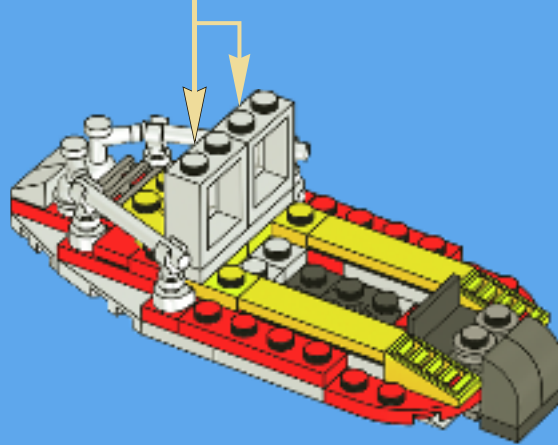
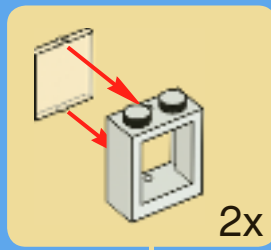

1x



1x



1x

19

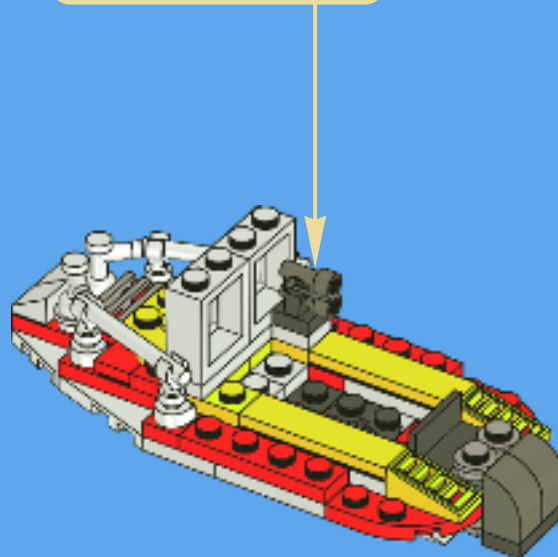
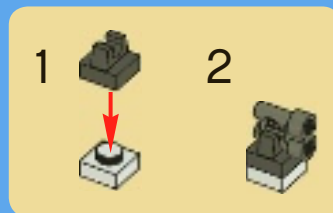



4x

20

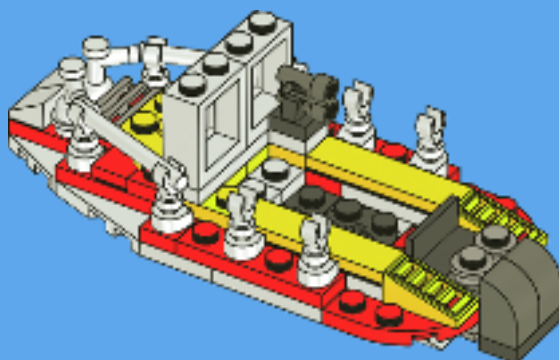

1x



1x



1x



1x

21

1



2



3

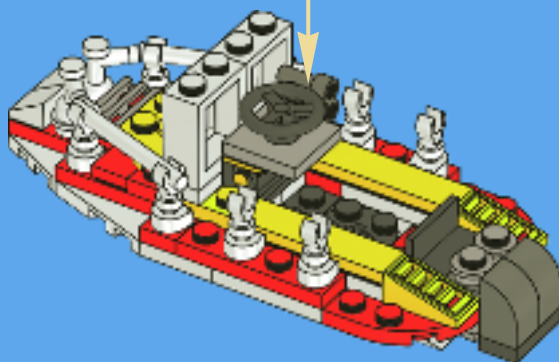



2x



2x

22

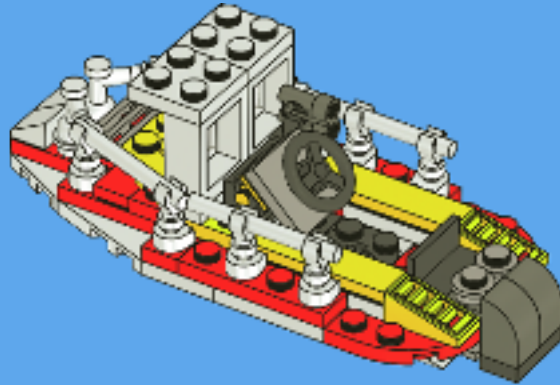

2x



2x



1x

23

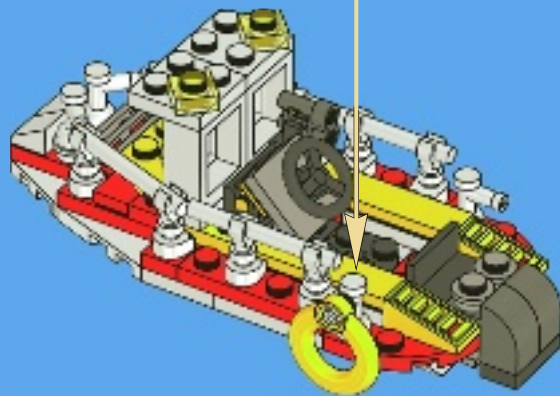



1x

24

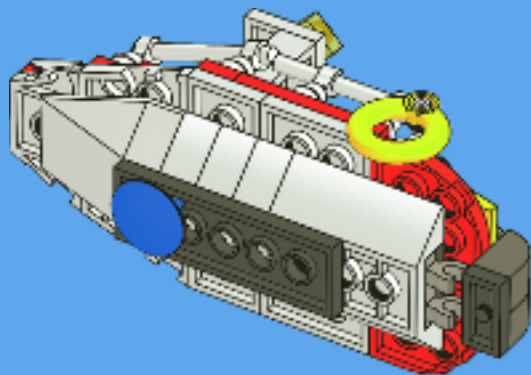

1x



1x

1





1x

2

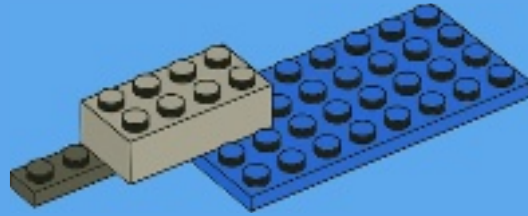

1

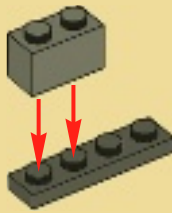

2

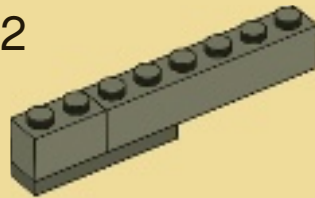

3

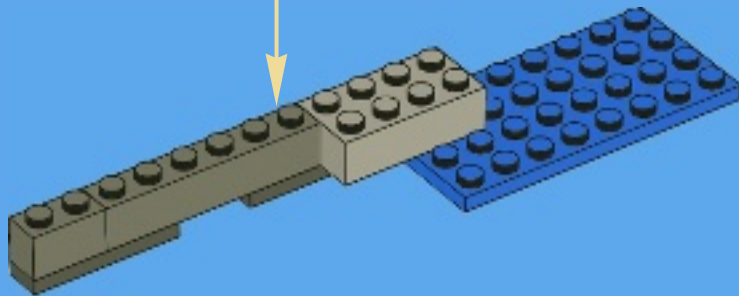



1x



1x

4

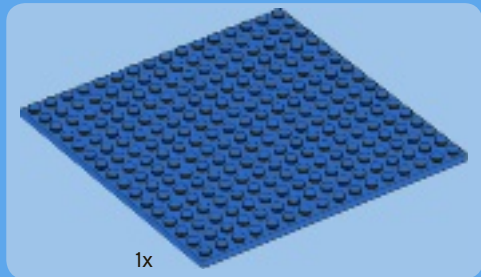
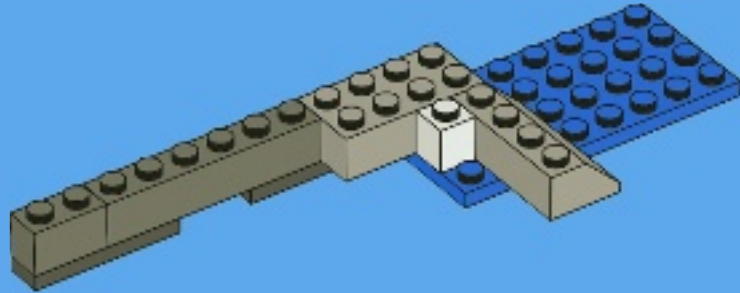

1x

5

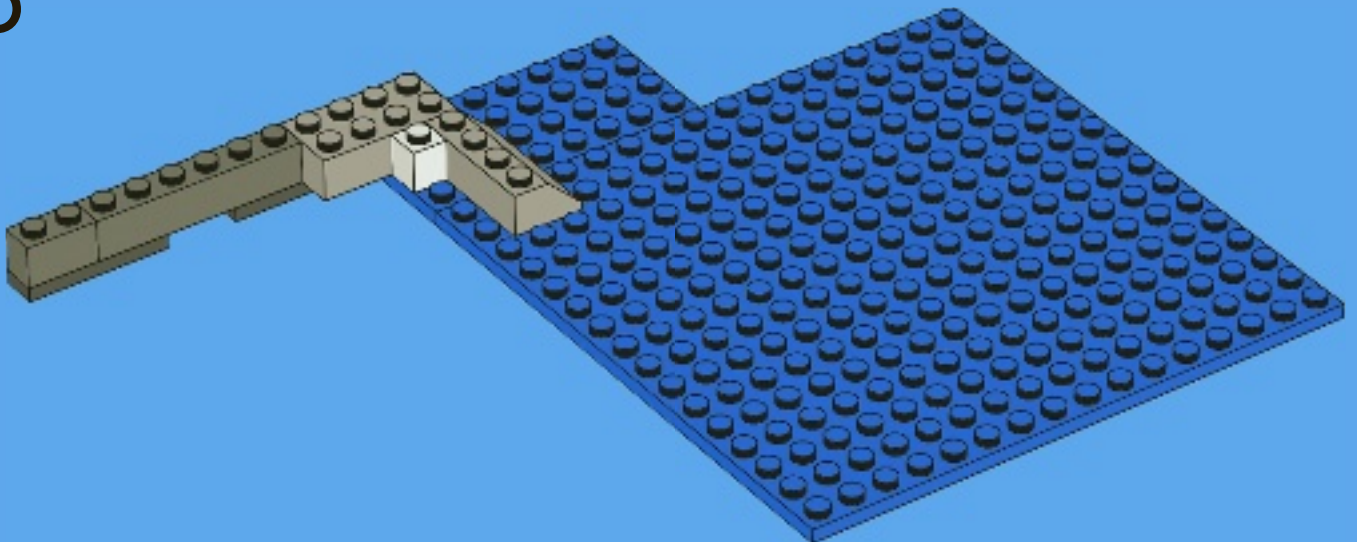

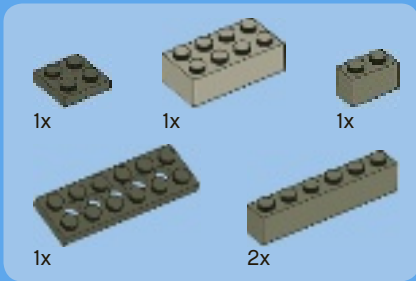

6

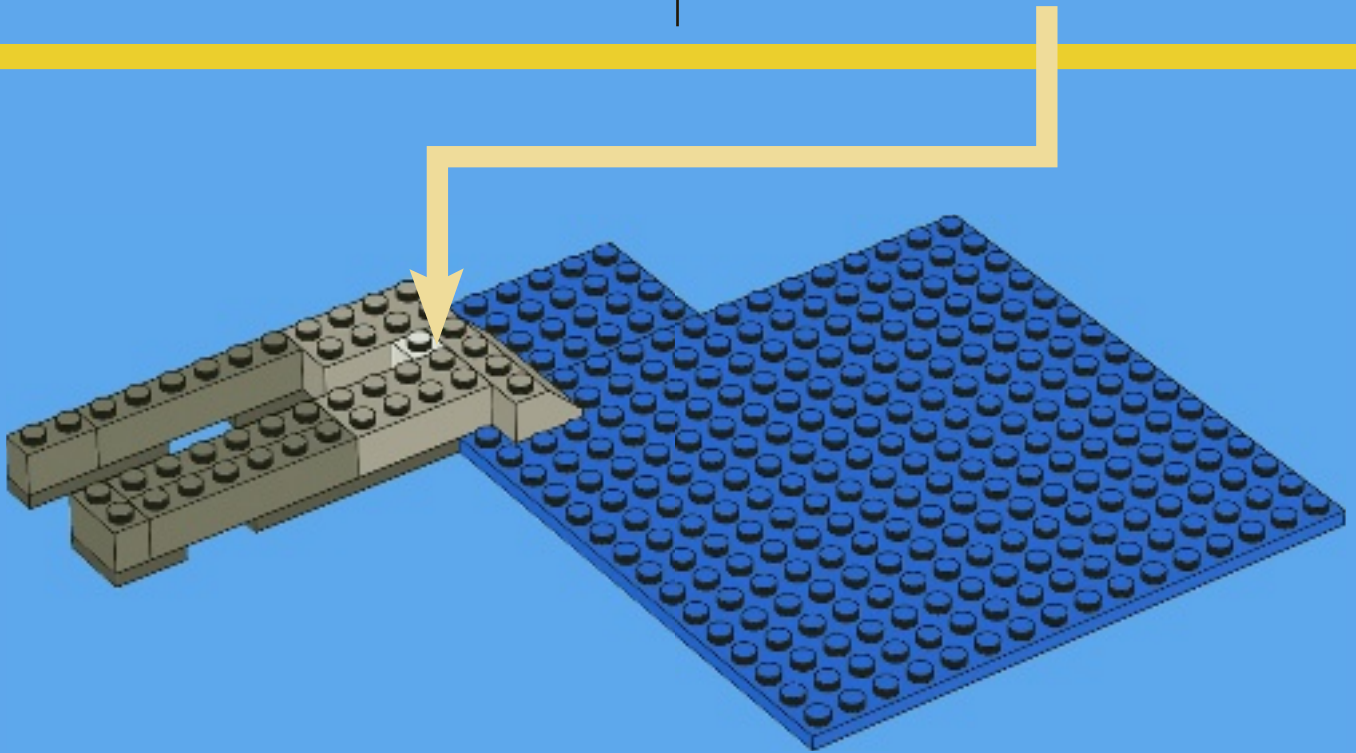
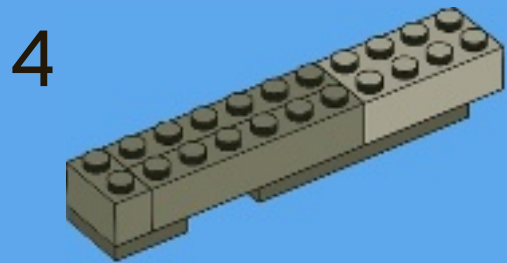
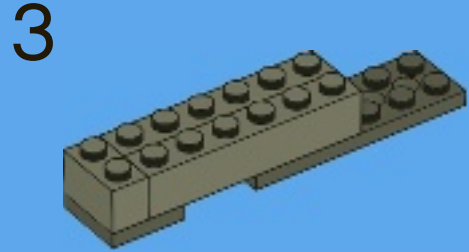
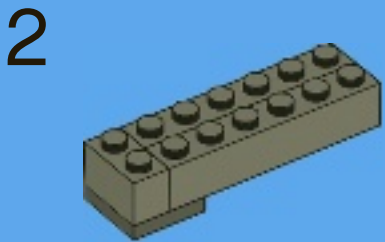
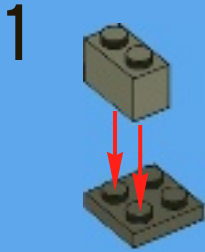



2x



2x



2x



1x

7

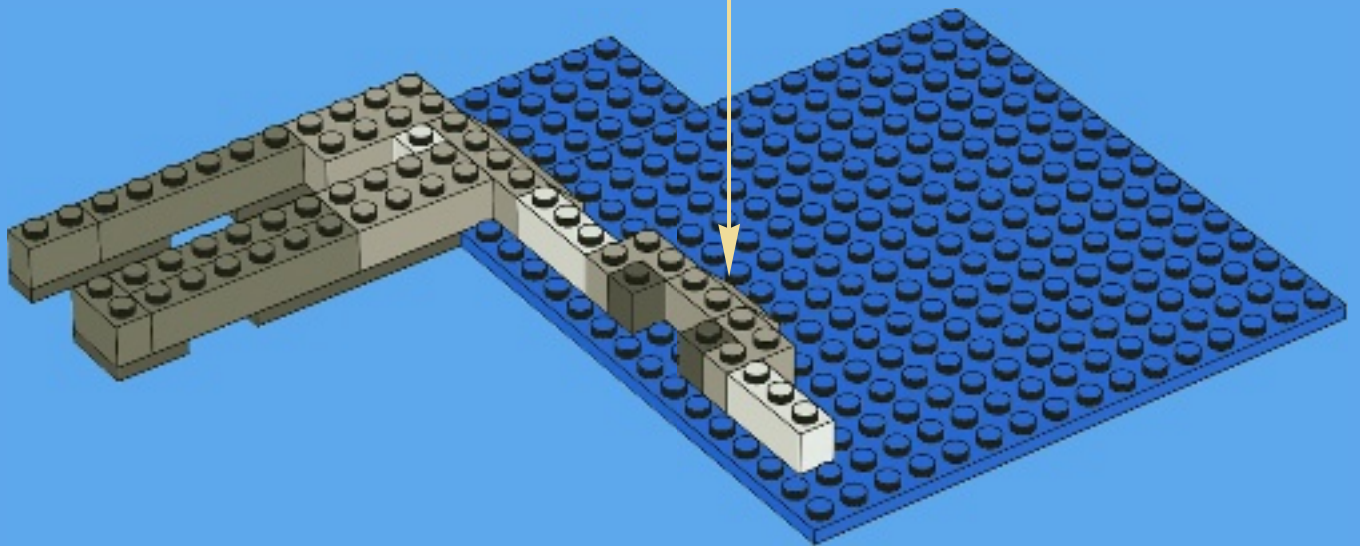
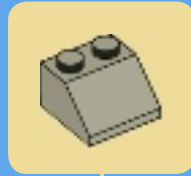

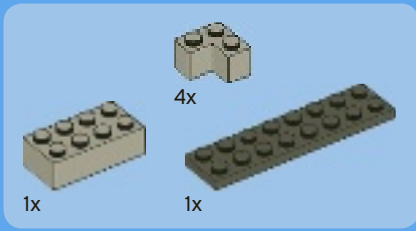

8

1

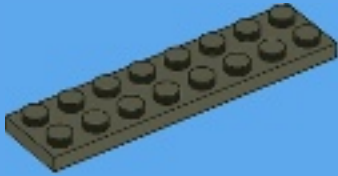

2

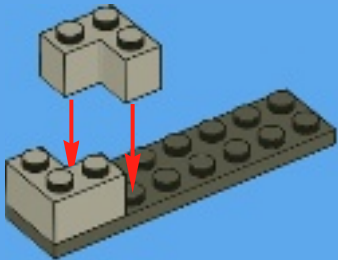

3

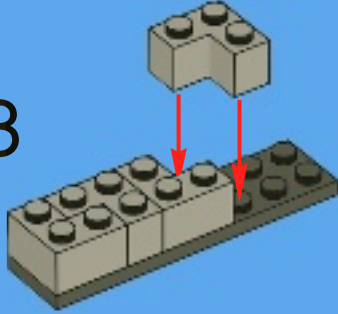

4

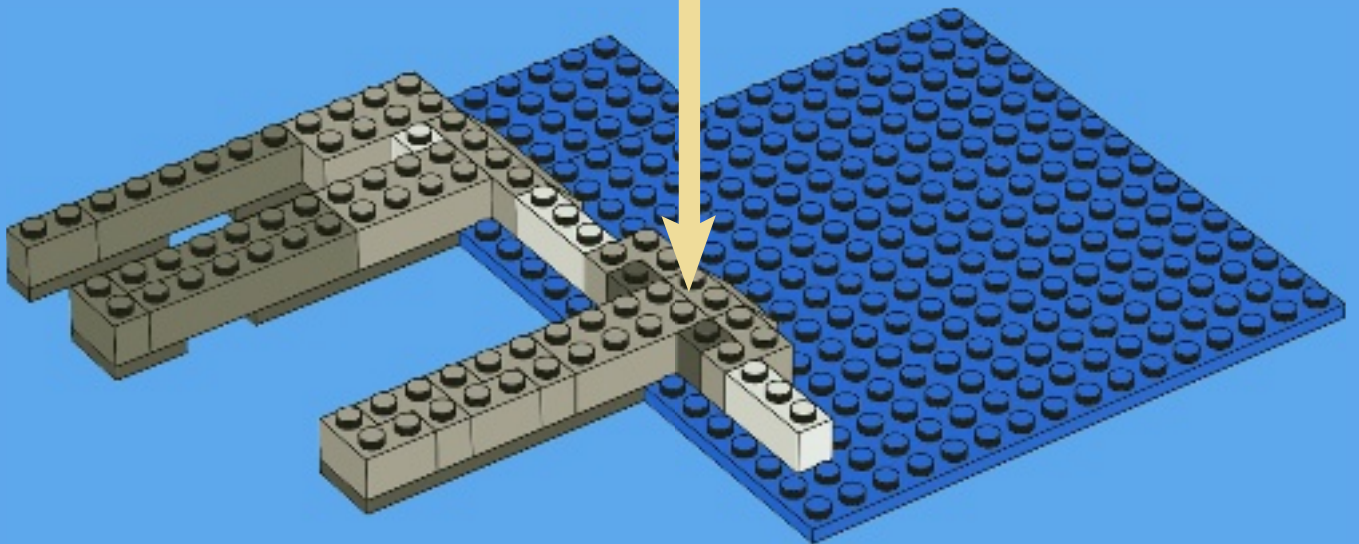
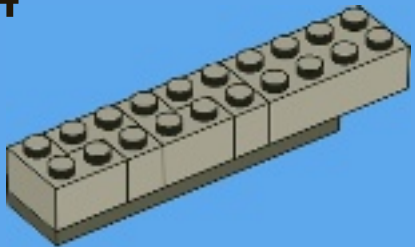

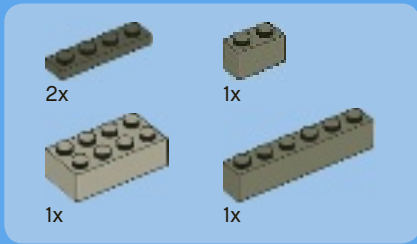

9

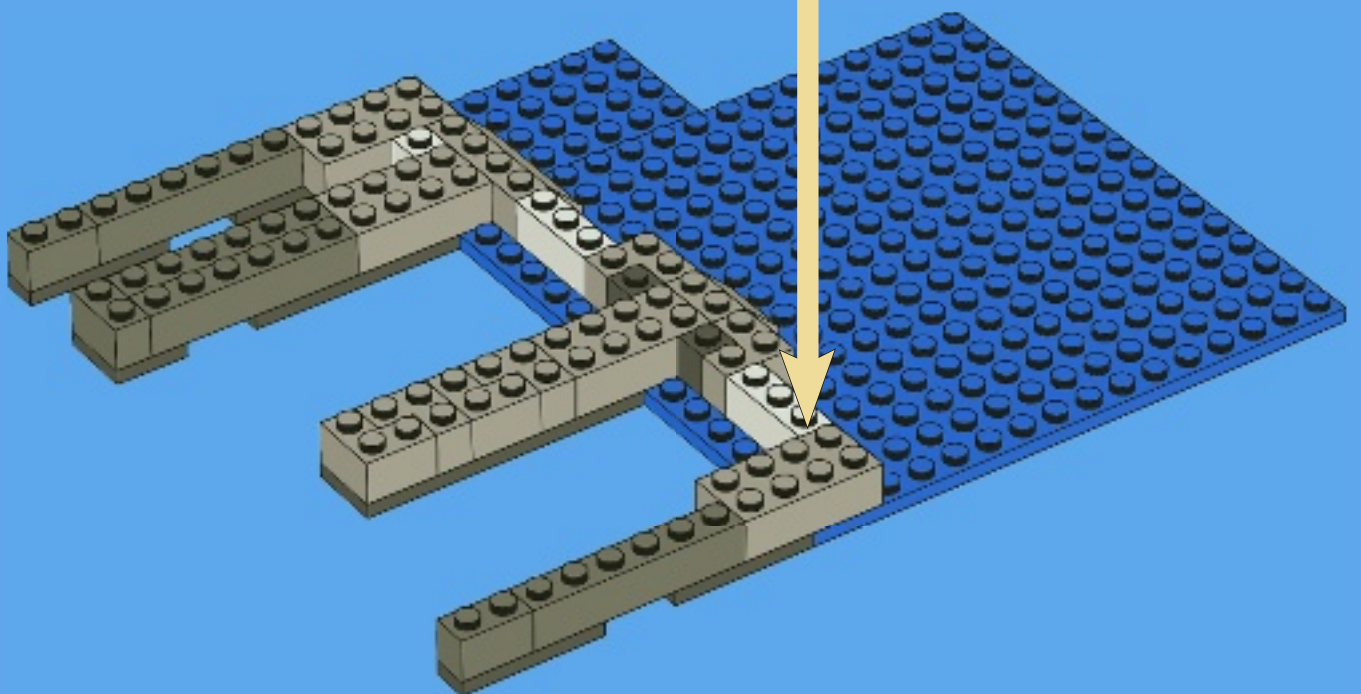
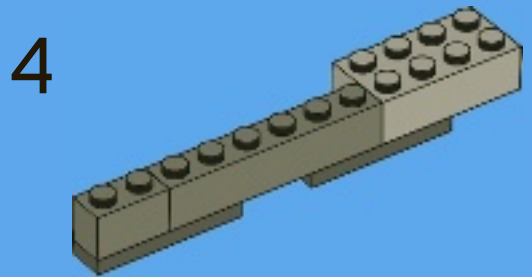
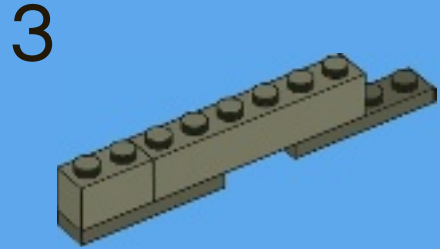
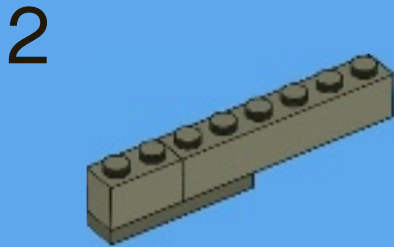
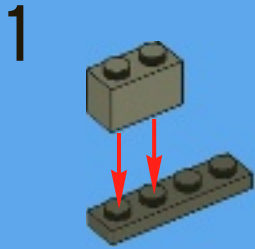



2x



2x

10

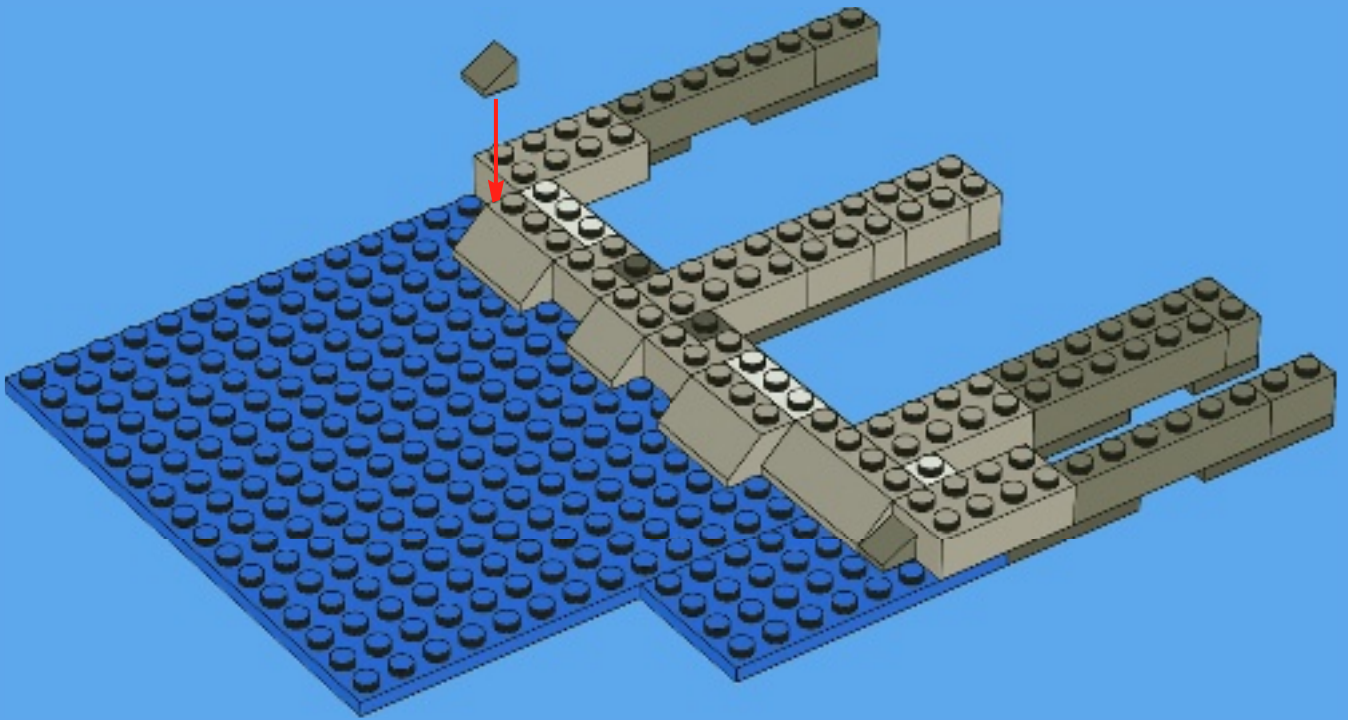



4x



2x

11

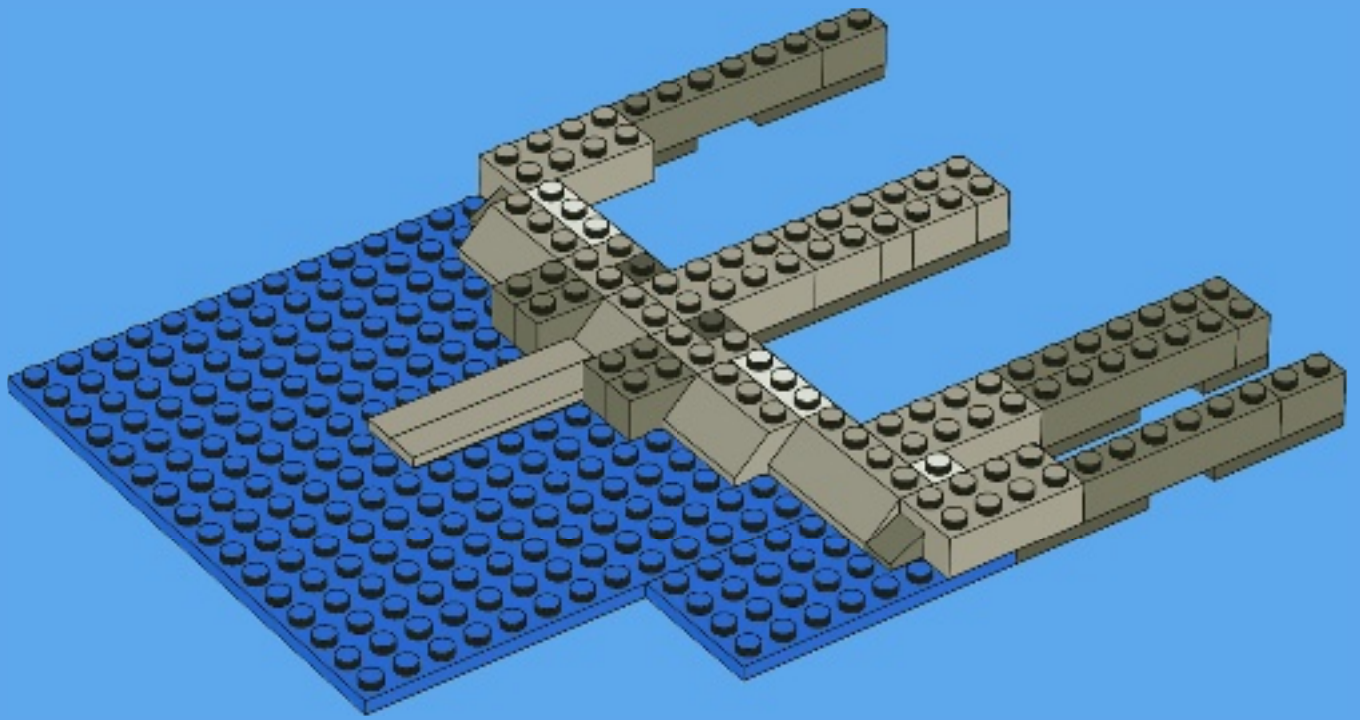

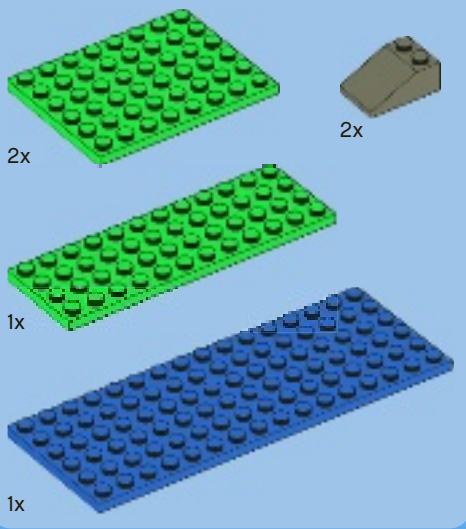

12

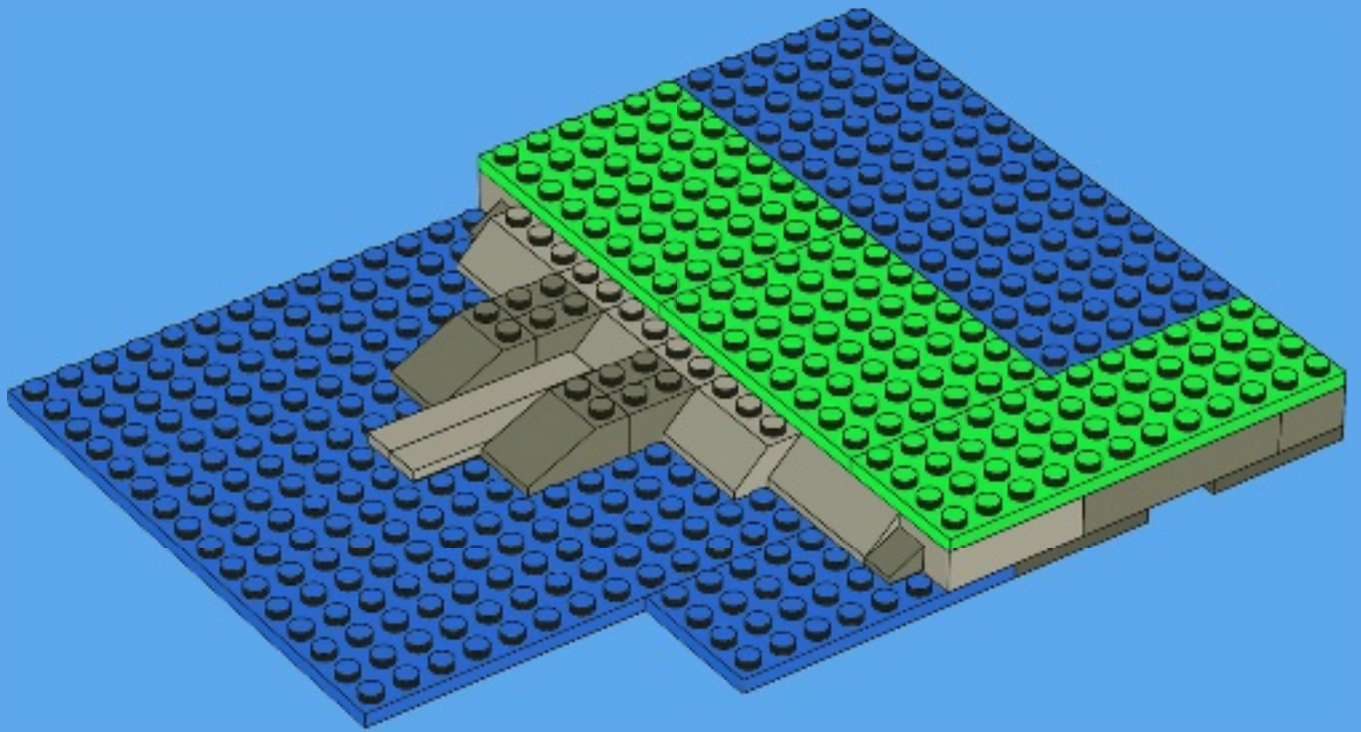



1x



1x

13

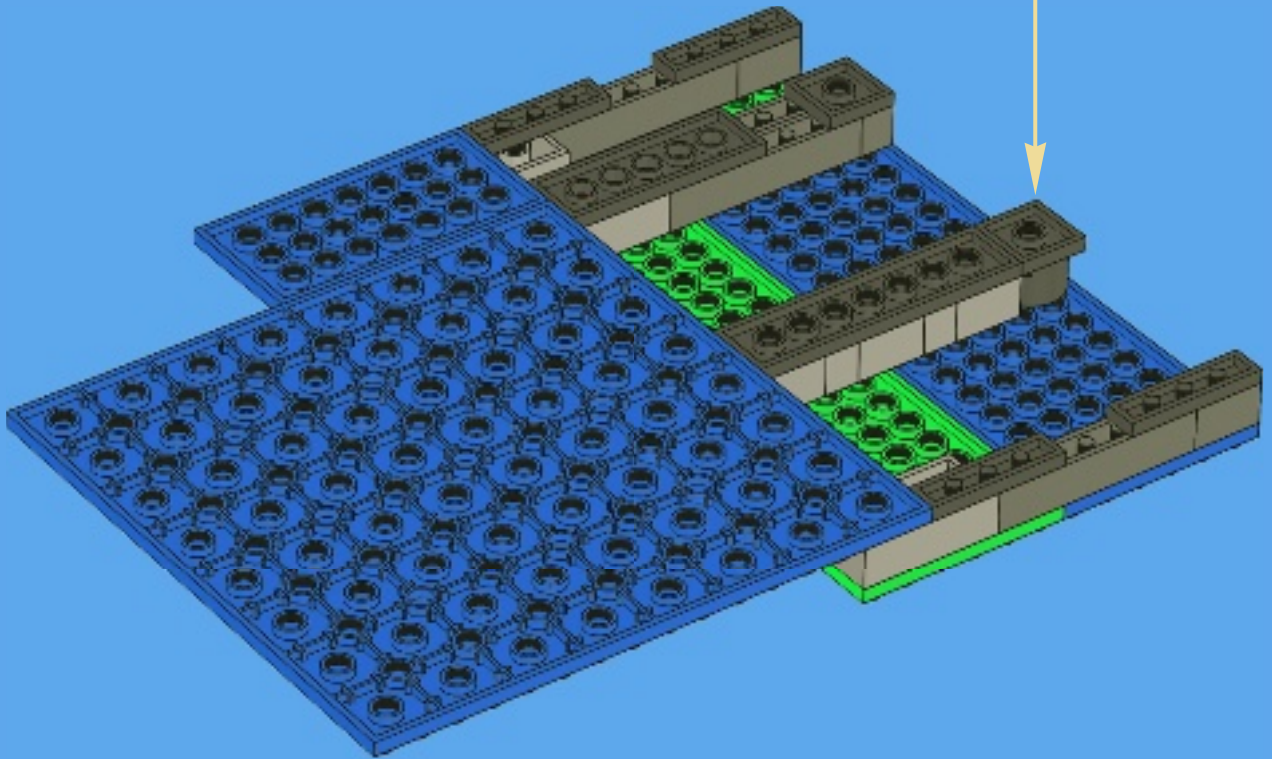
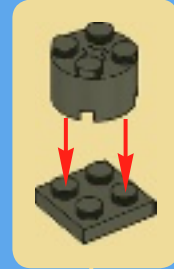



14

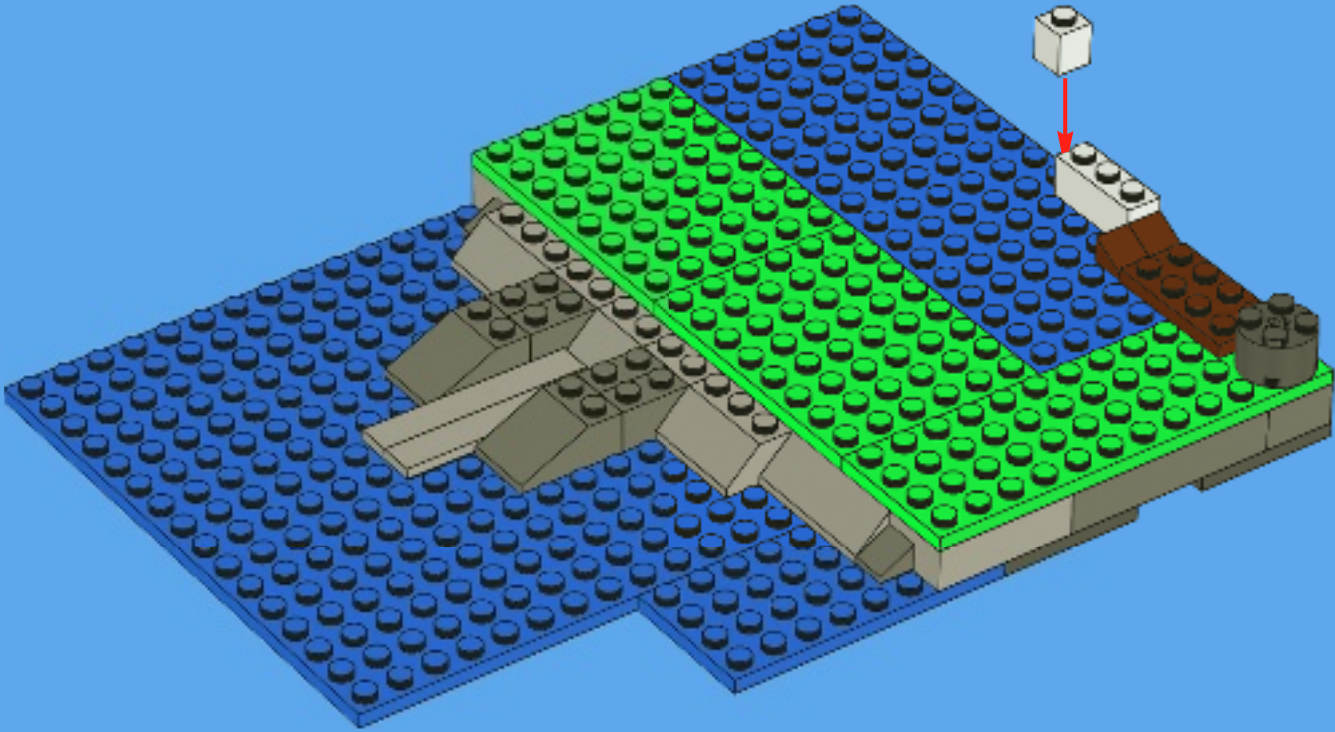



1x



2x



1x



1x



1x



2x

15

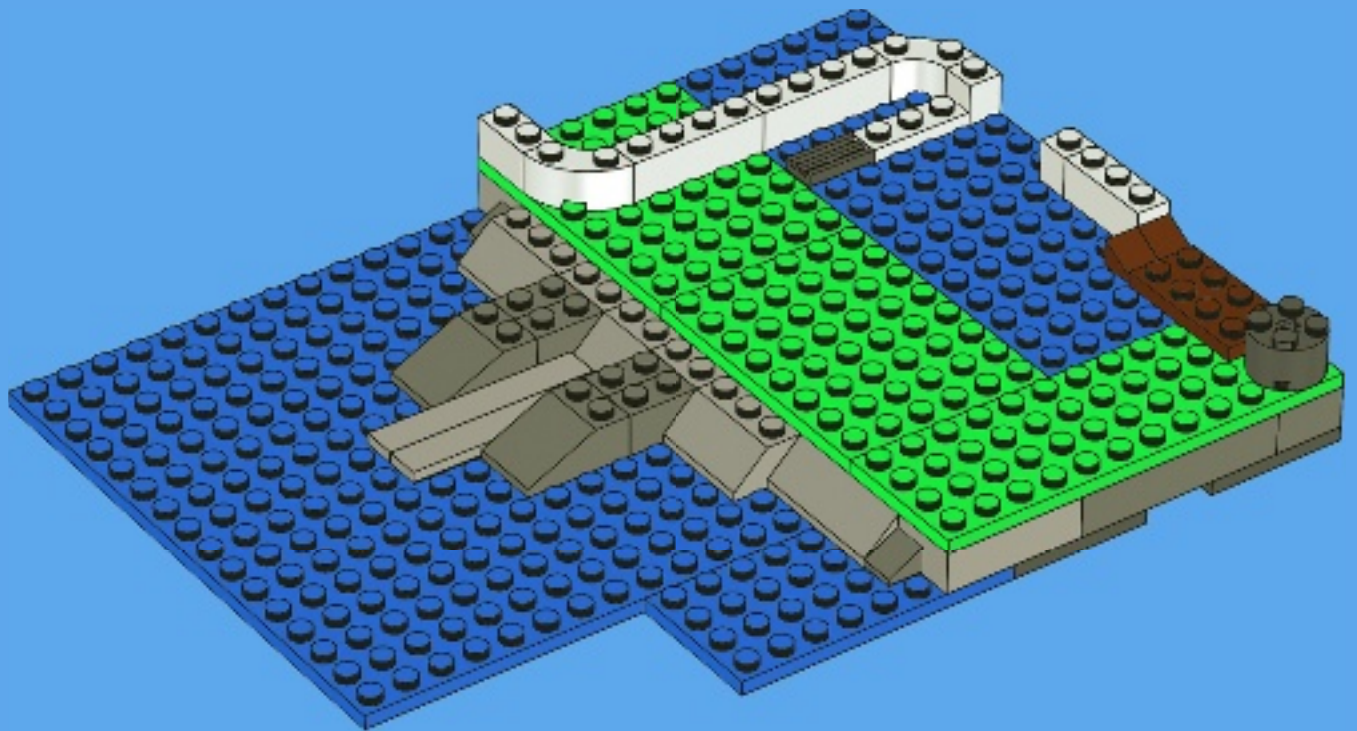



2x



1x



1x

16

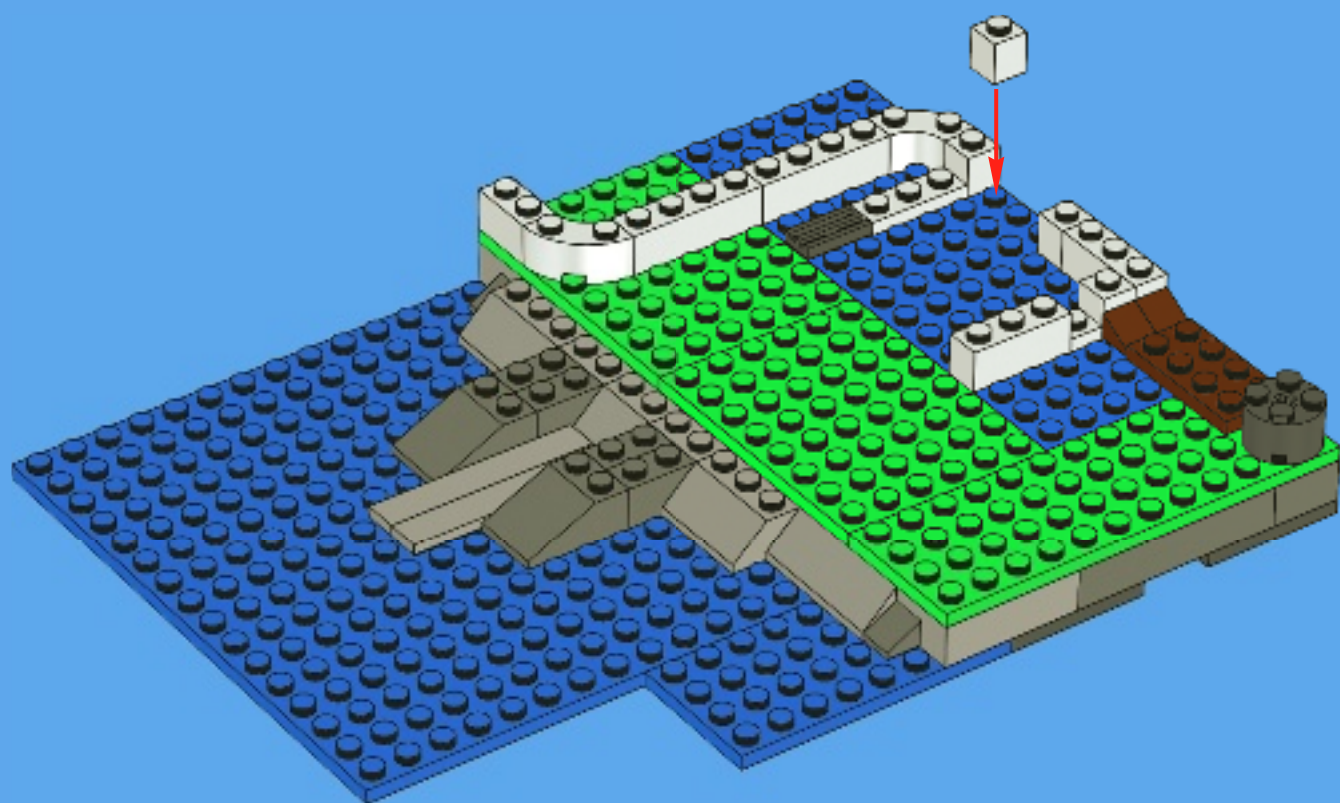

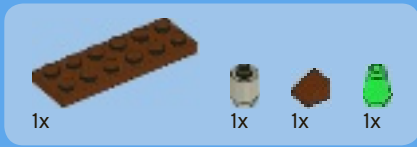

17

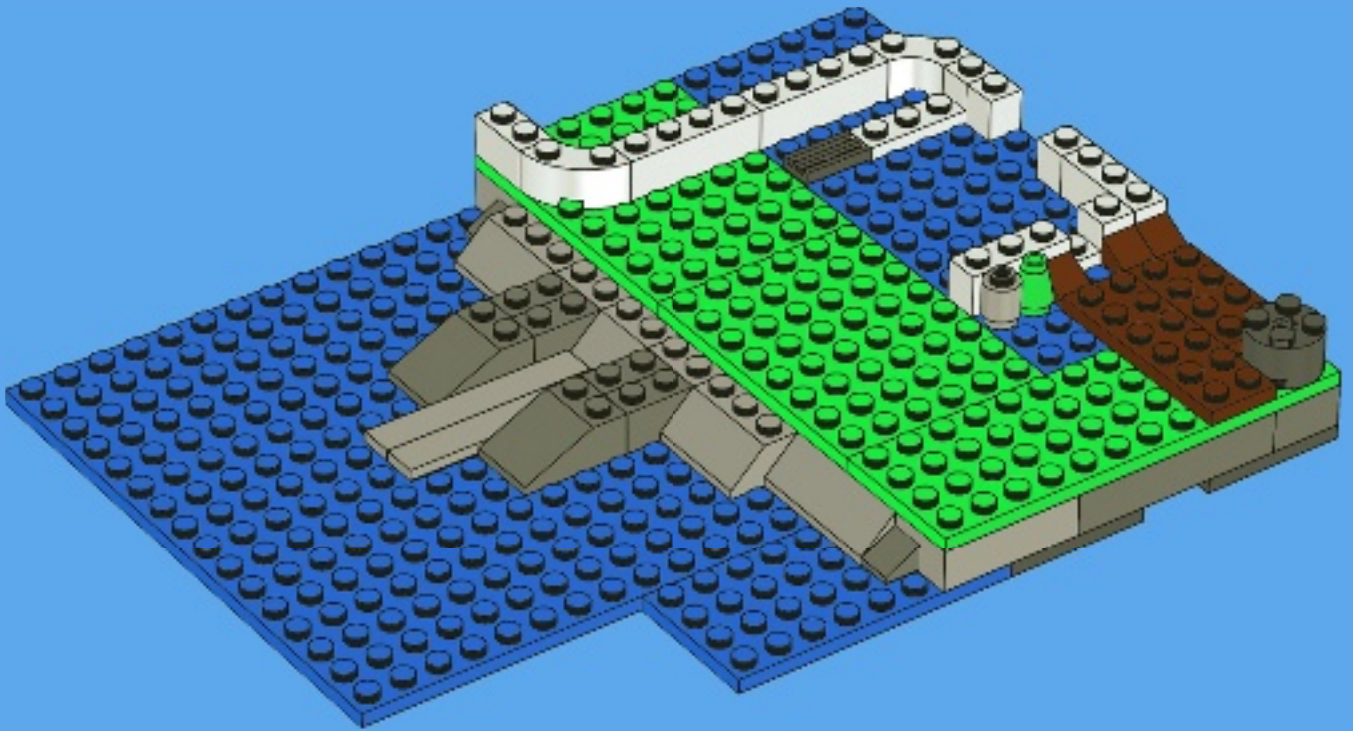



1x



1x

1

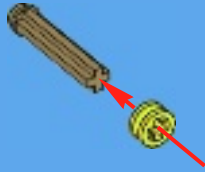

1x



1x

2



1x



1x

3



1x

4

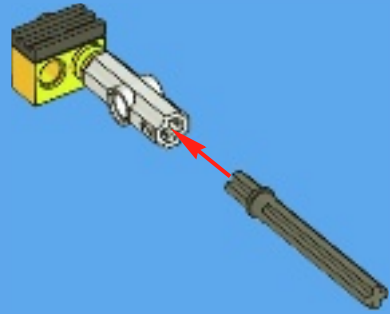

2x

5

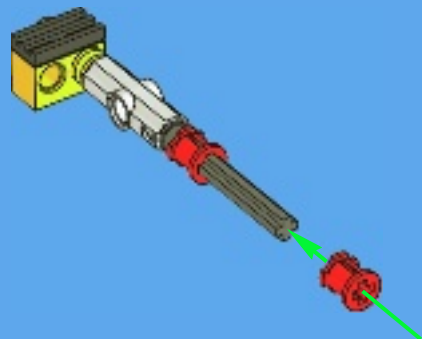



1x



1x

6

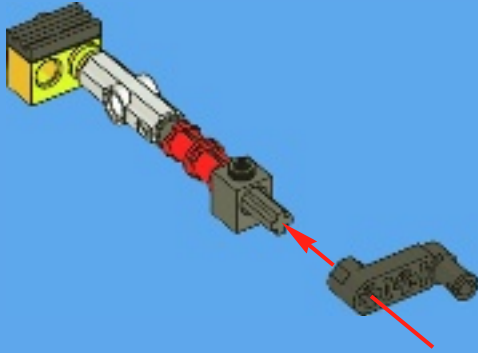

1x



1x

7

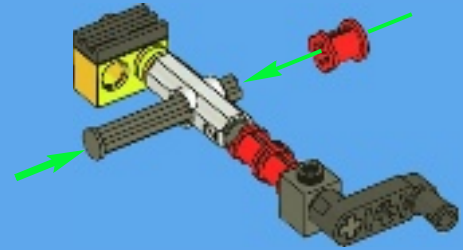

18

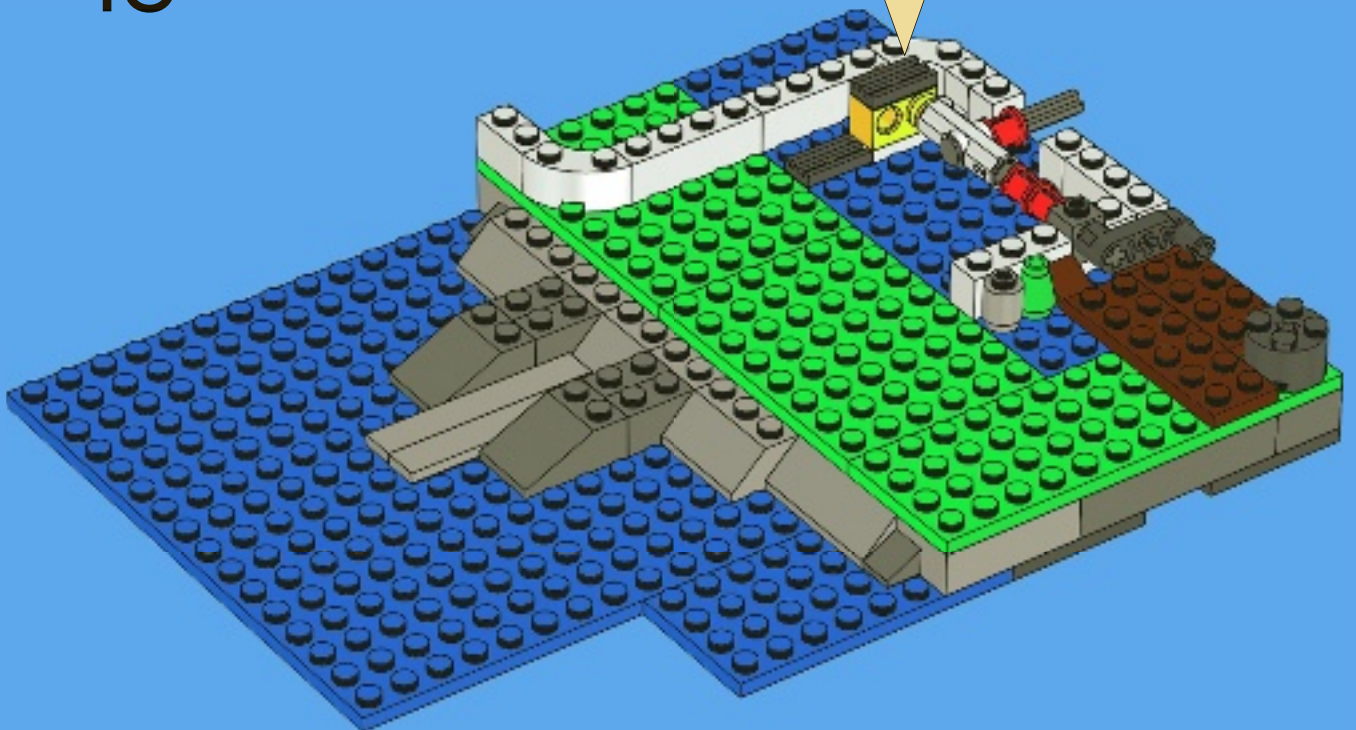

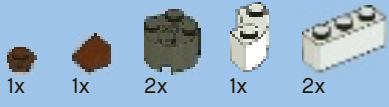

19

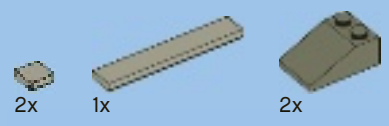
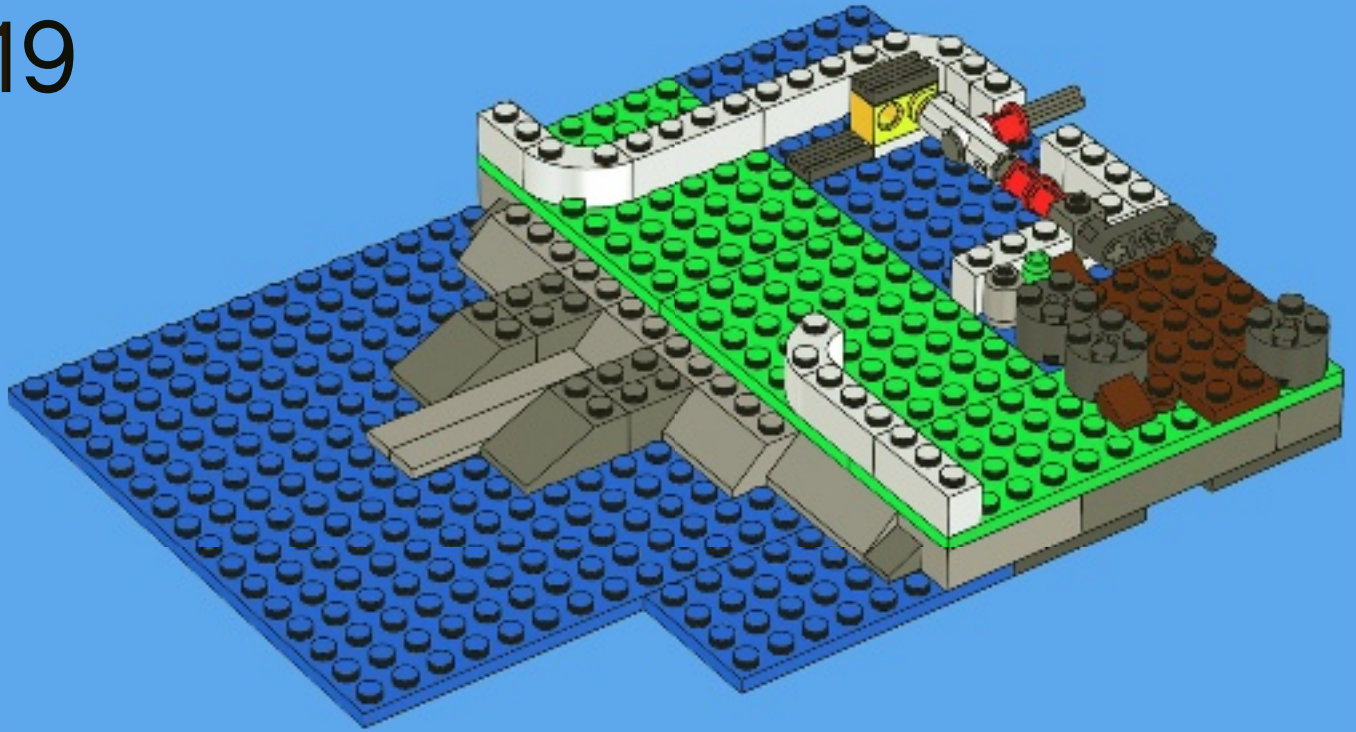

20

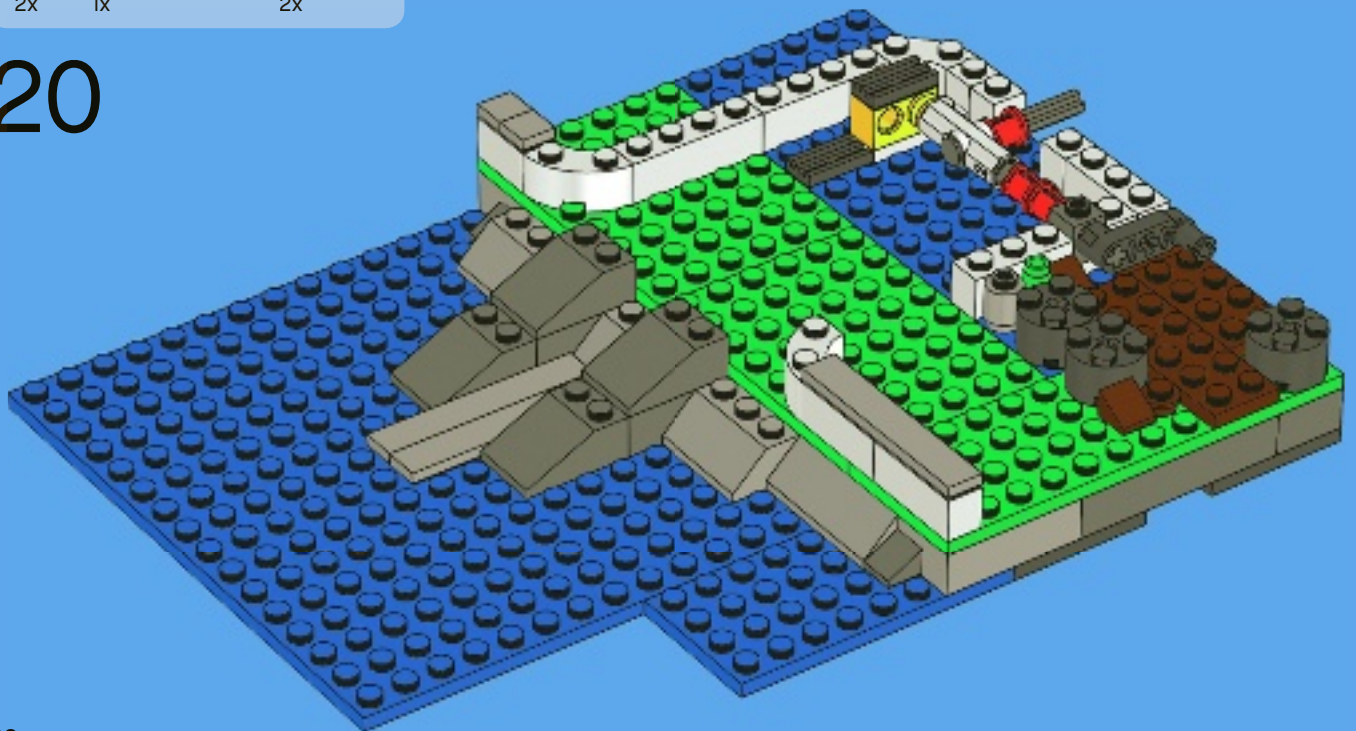



2x



4x

21

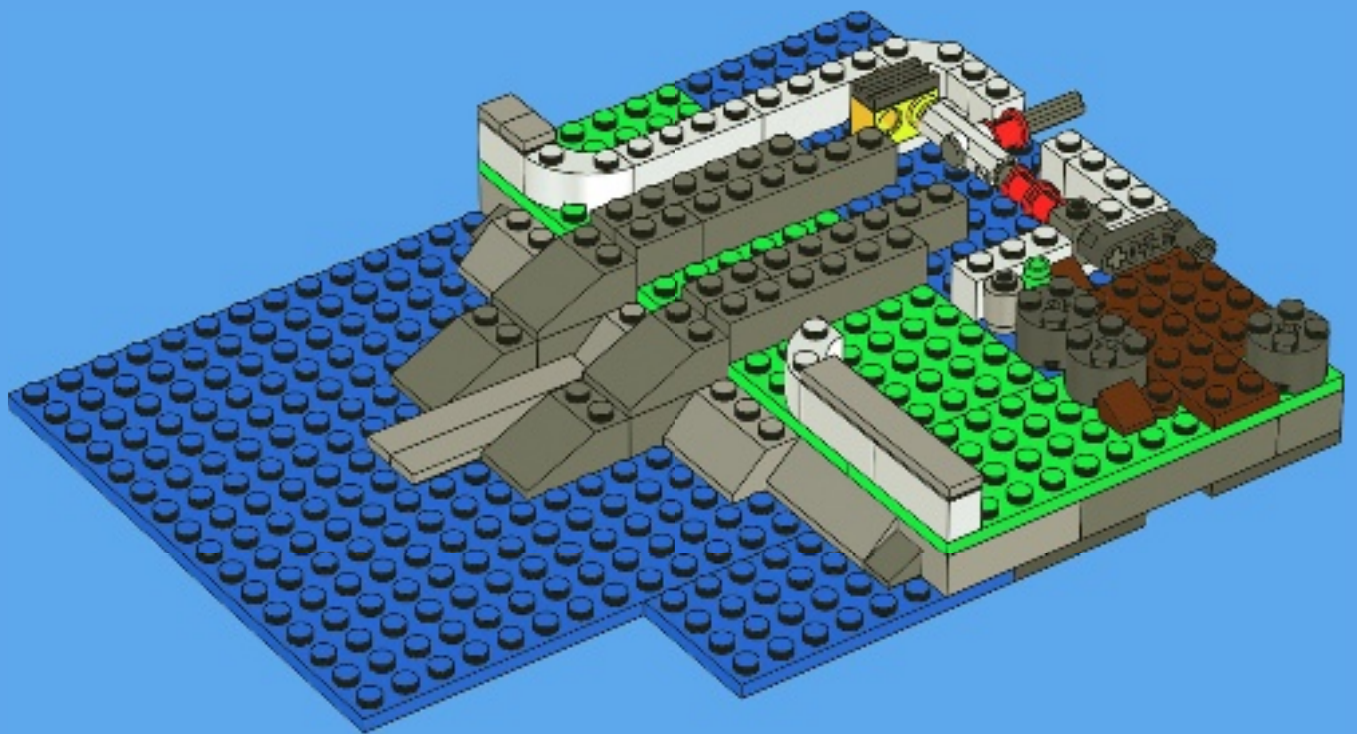



2x



2x



2x



1x

22

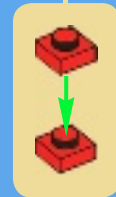
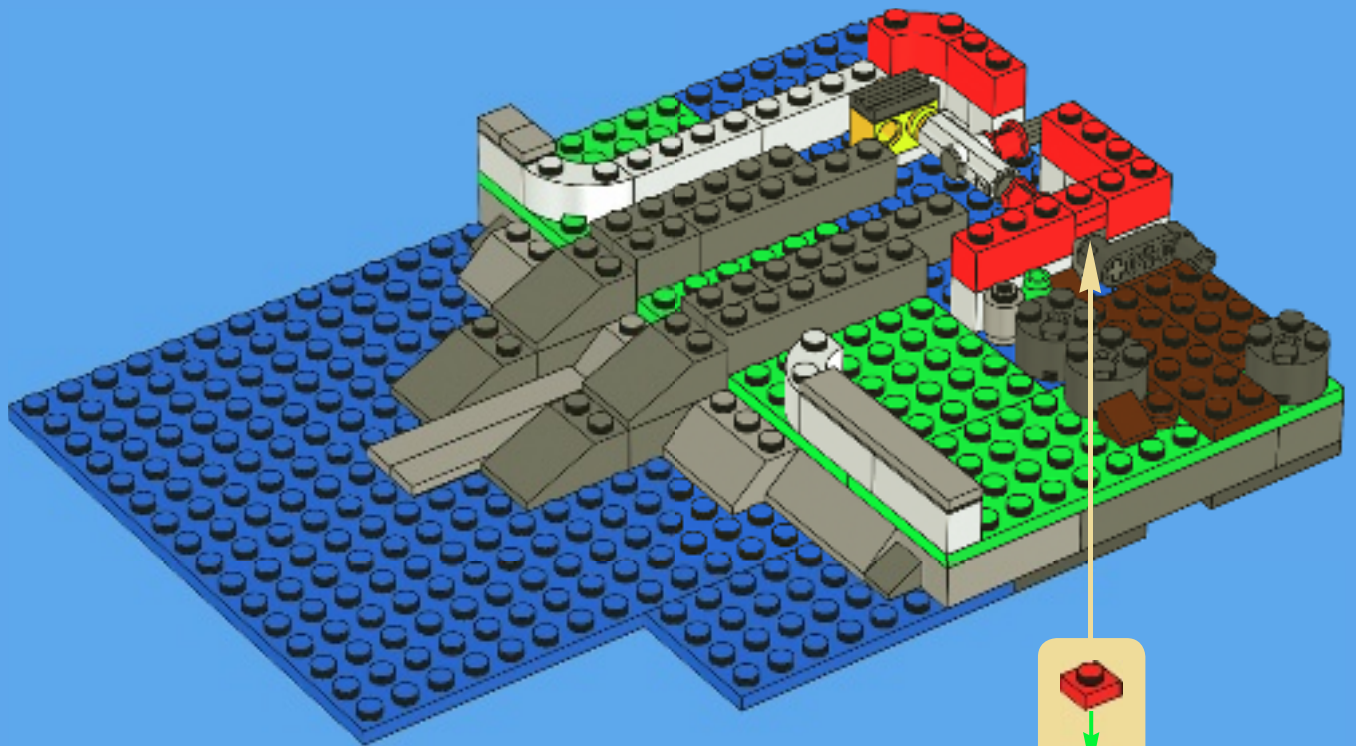



23

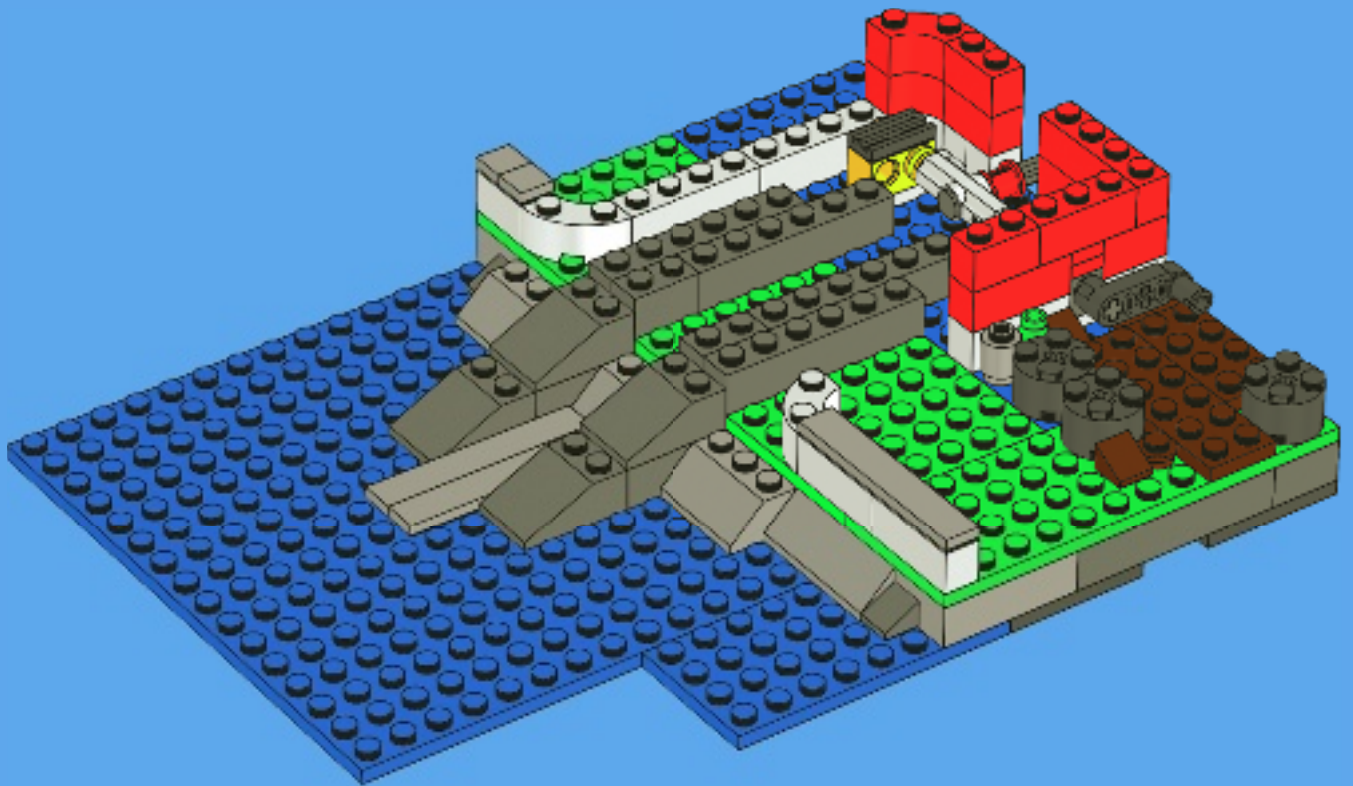



2x



1x



2x



2x



2x



1x



1x

24

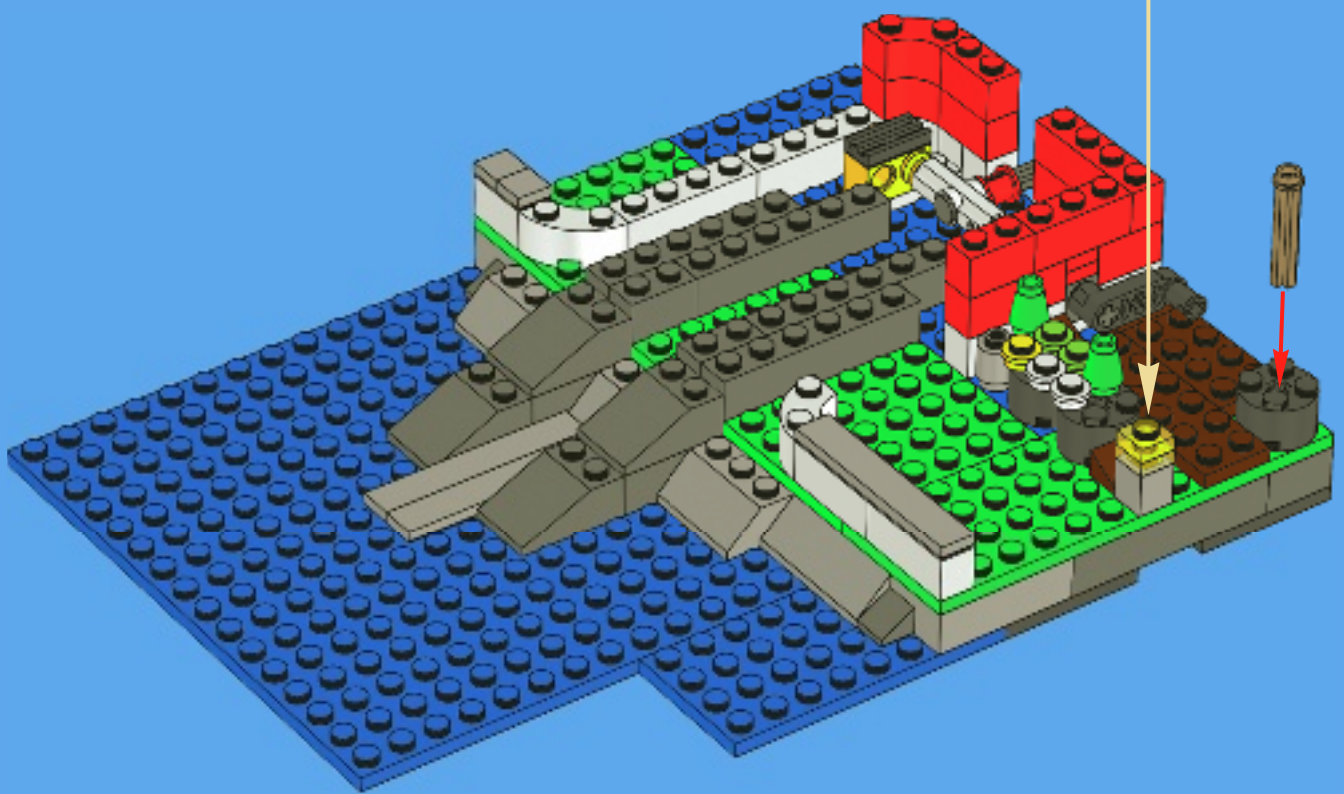
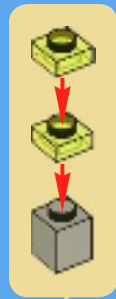



1x



1x



1x



1x



1x



1x

25

1

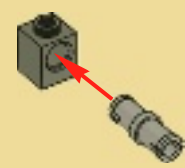

2

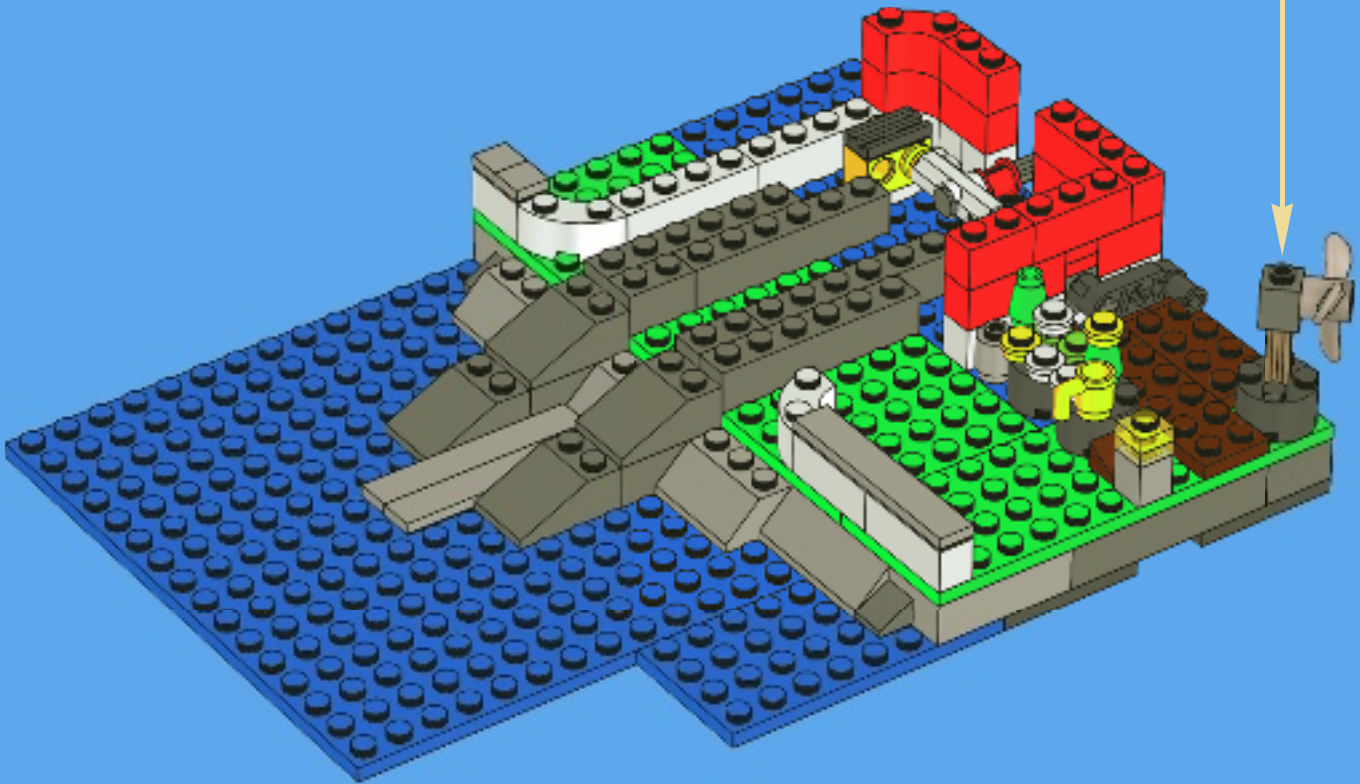

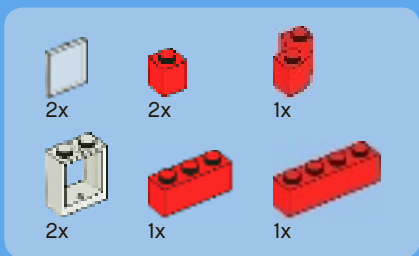

27

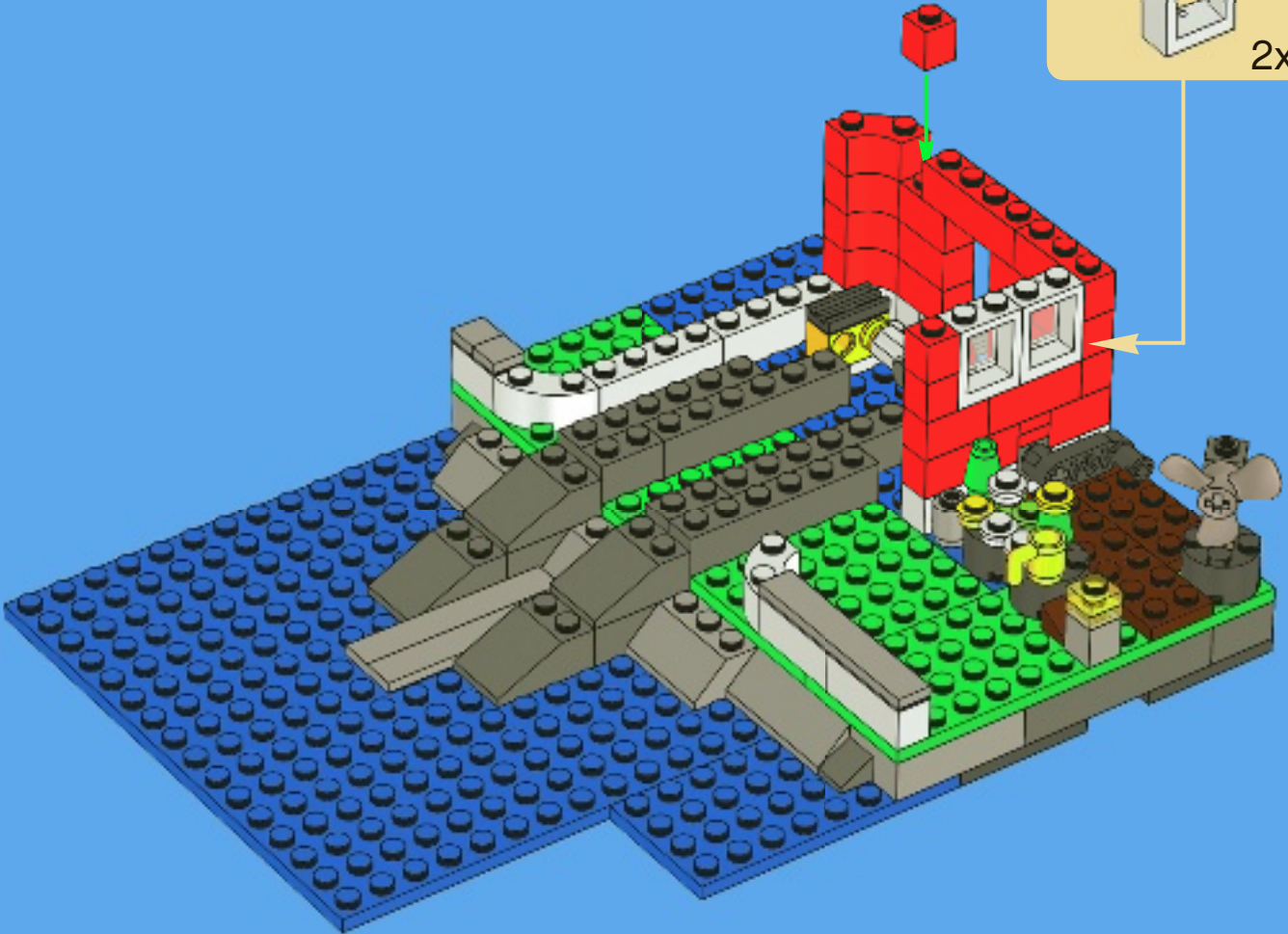
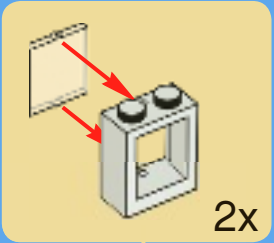



28

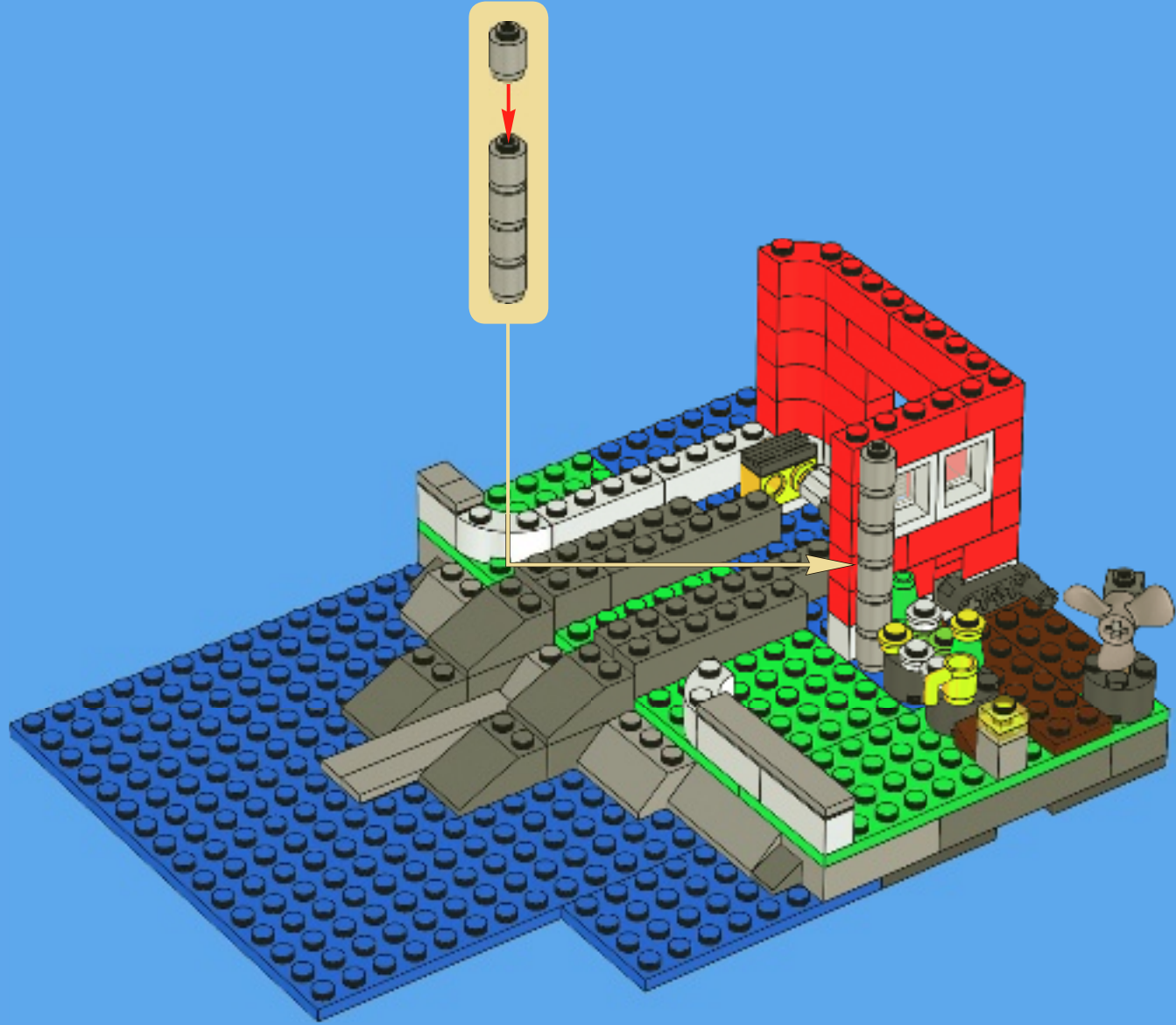

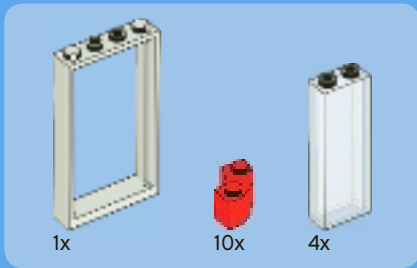

29

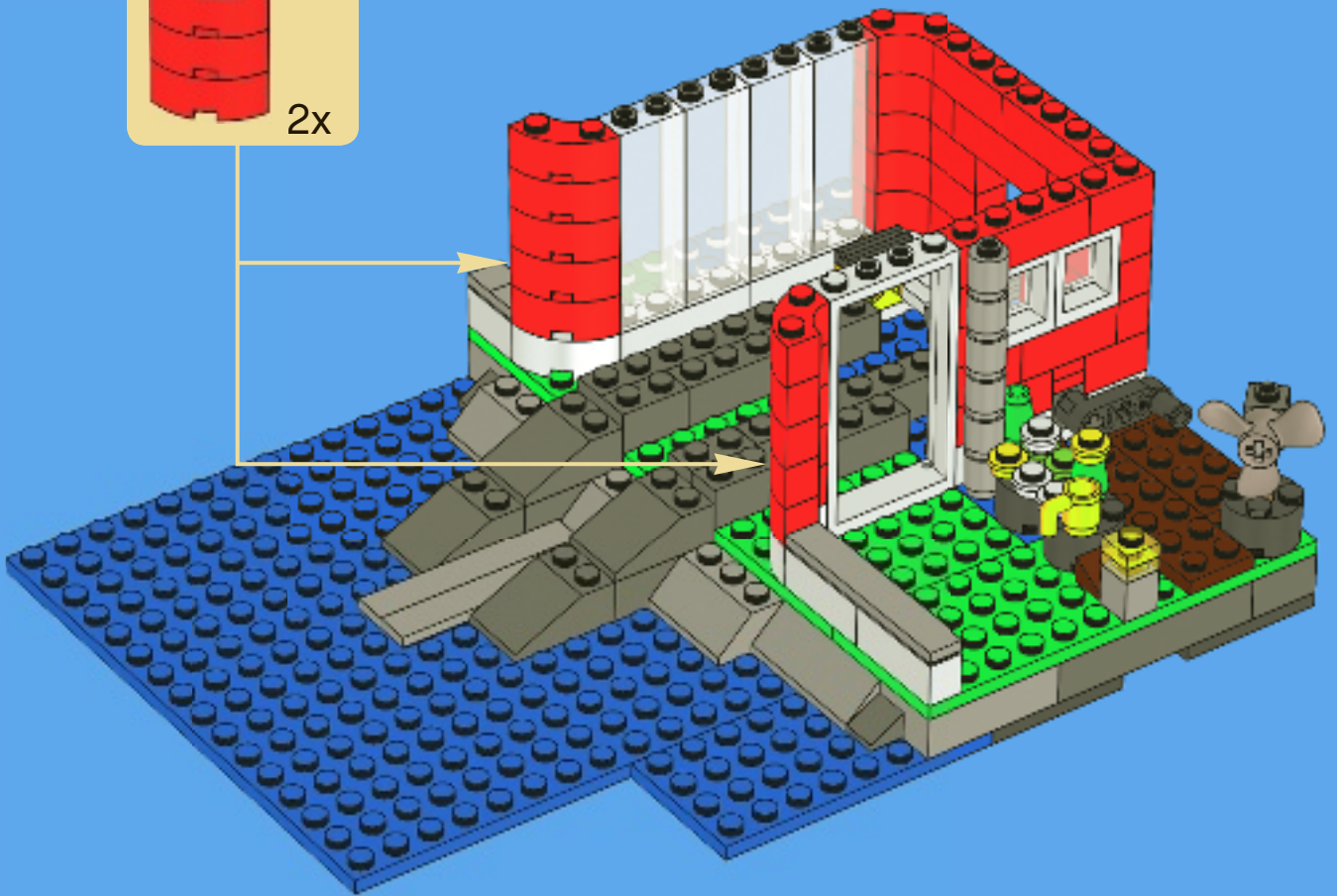
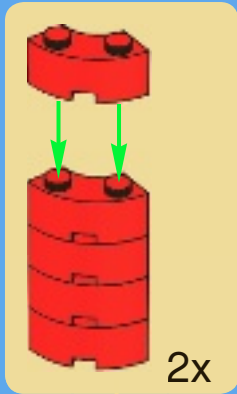



4x



4x



2x



8x

30



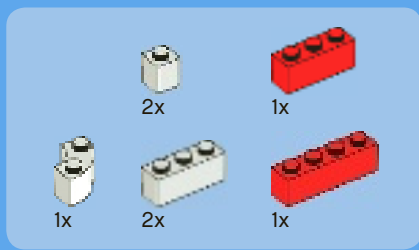

31





2x

1

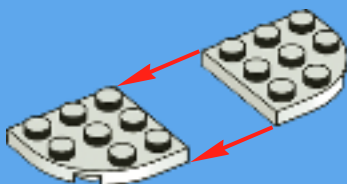

1x



1x

2



2x

3



1x

4



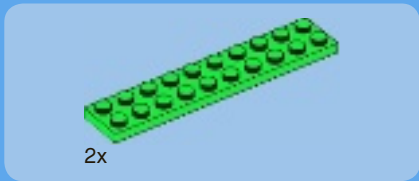

5

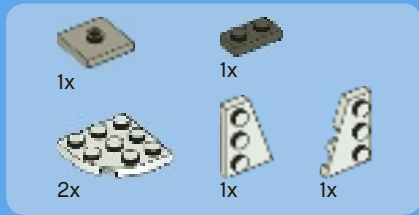
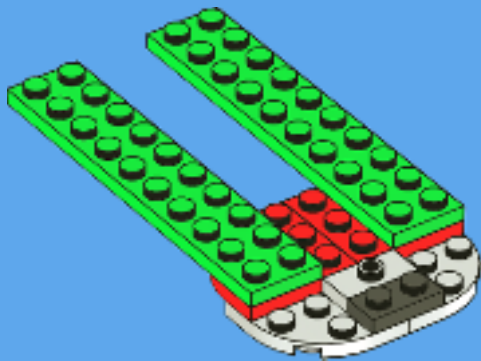

6

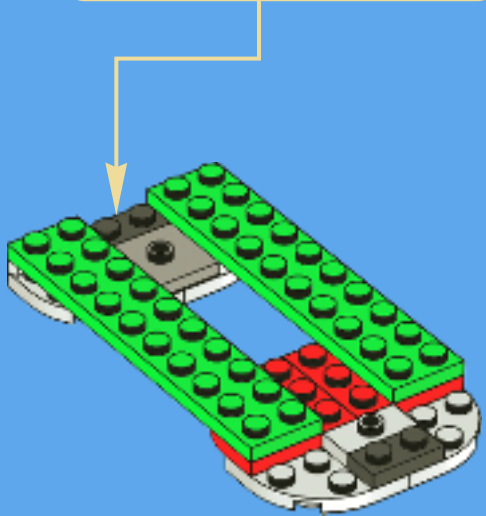
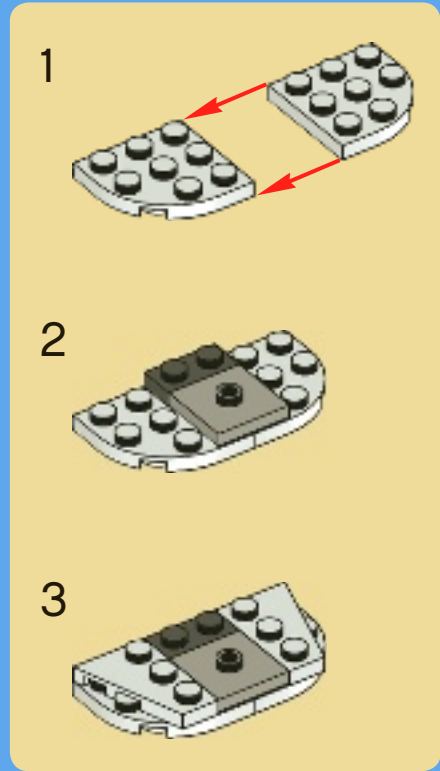



2x

7

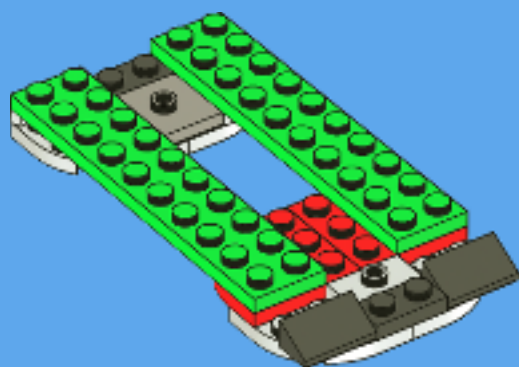

32



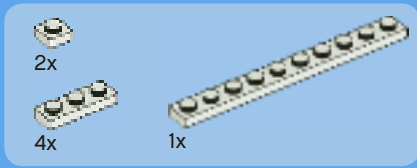

33

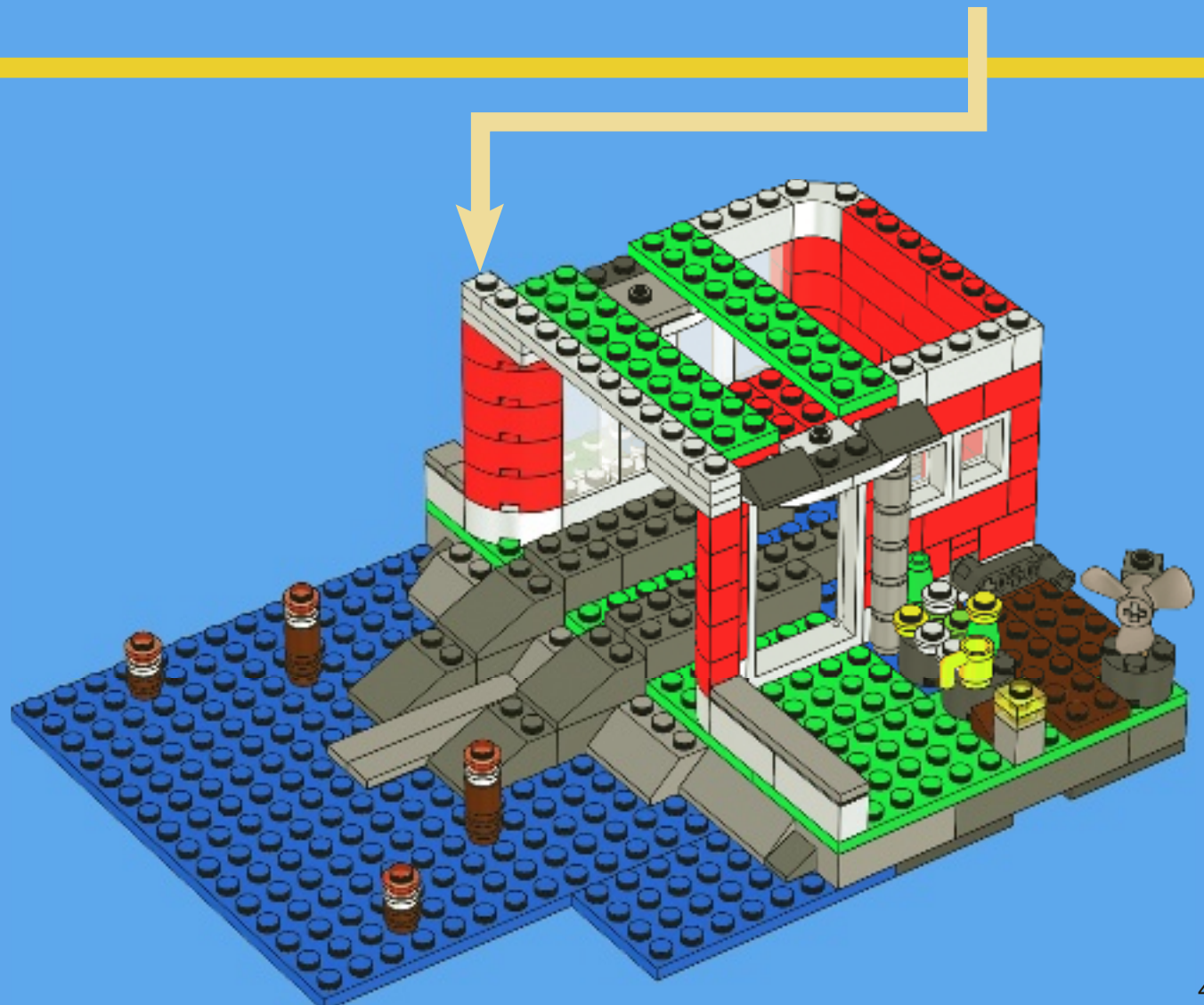
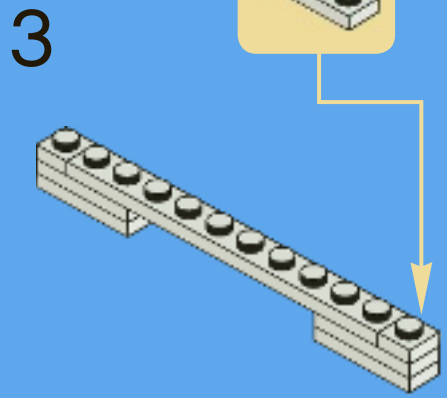
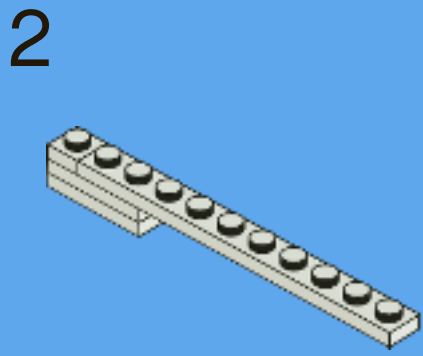
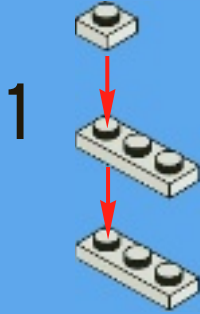

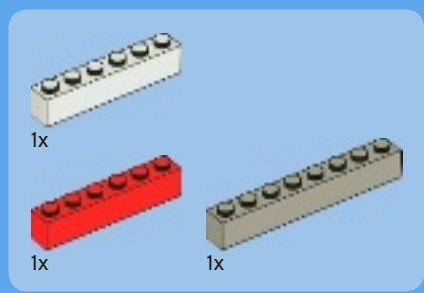

34





1x



2x



2x

35





1x



4x

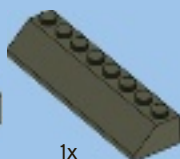

1x

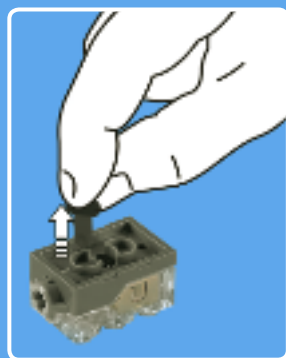

36





1x



1x



1x

37

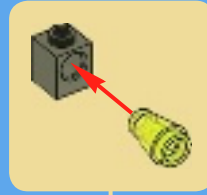



1x



2x



1x



2x

38





4x



2x



2x



1x

39





40

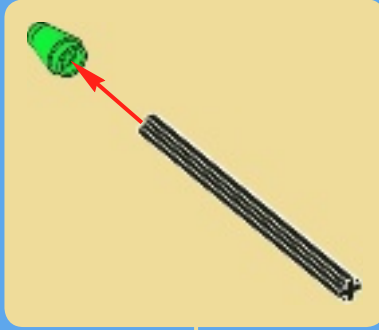

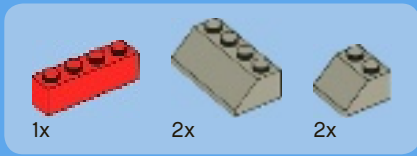

41

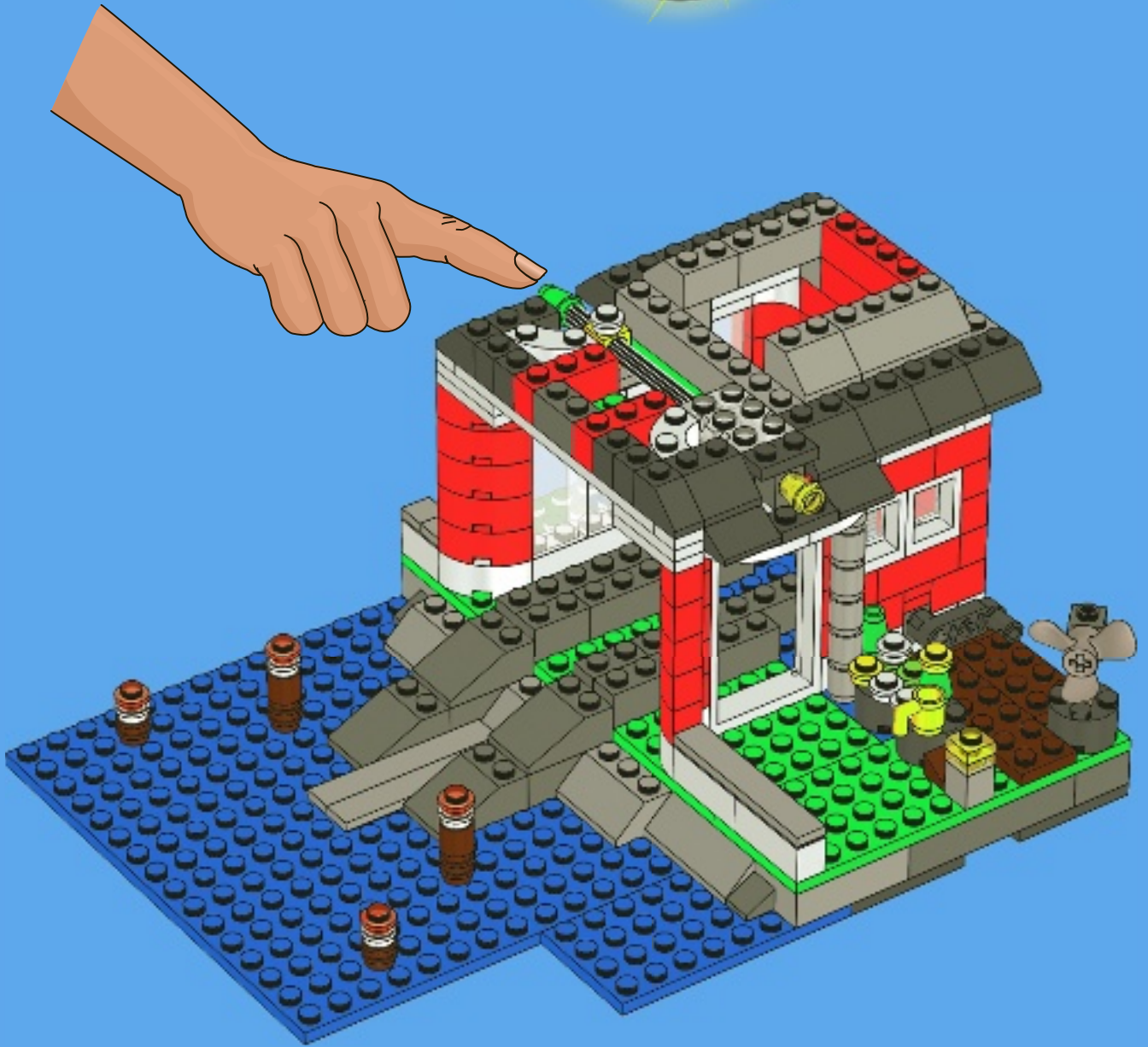

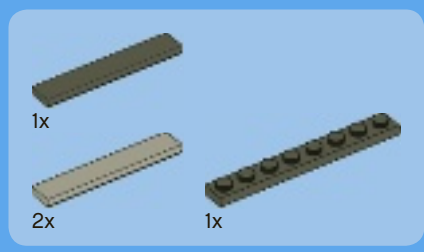

42

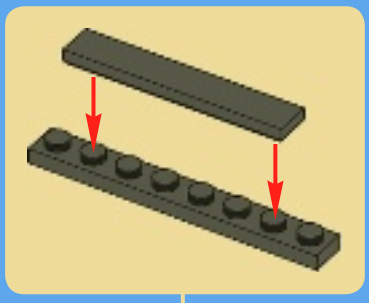



2x



1x



2x

43





1x



4x

44



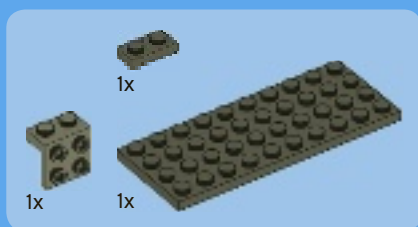

45





1x



2x







46

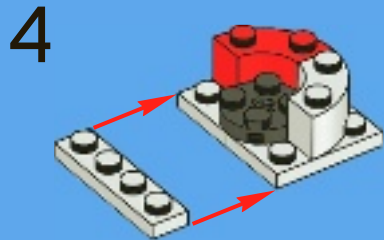
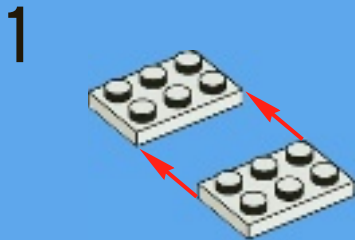



47



- 2x 
- 2x 
- 2x 
- 2x 
- 2x 
- 2x 
- 1x 

48

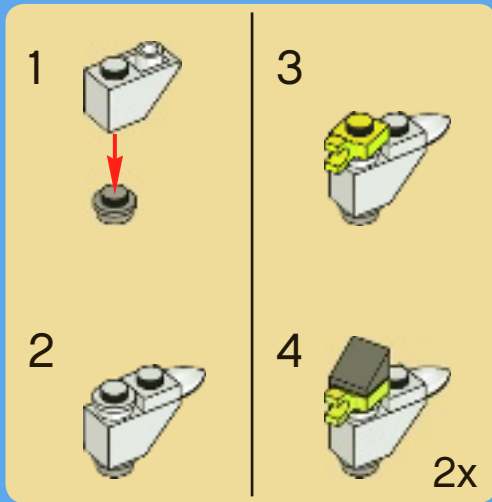





WIN!

Go to www.LEGOsurvey.com/product to fill out a survey for a chance to win a cool LEGO® Product. No purchase necessary. Open to all residents where not prohibited.

 www.LEGO.com



www.LEGOsurvey.com/product

GEWINNE!

Nimm an der Umfrage auf www.LEGOsurvey.com/product teil und hab die Chance ein cooles LEGO® Produkt zu gewinnen!

Die Teilnahme am Gewinnspiel führt zu keinerlei Kaufverpflichtungen. Teilnahme in allen nicht ausgeschlossenen Ländern möglich.

WIN!

Ga naar www.LEGOsurvey.com/product, vul een enquêteformulier in en maak kans op een cool LEGO® product.

Geen aankoopverplichting. Iedereen mag deelnemen, uitgezonderd ingezetenden van landen waar een enquêteverbod geldt.

GAGNE!

Visite www.LEGOsurvey.com/product pour répondre à un questionnaire et avoir une chance de gagner un produit LEGO® très cool!

Aucune obligation d'achat. Ouvert à tous les résidents des pays autorisés.

当てよう!

www.LEGOsurvey.com/product にアクセスして、アンケートにご記入ください。当選者にはレゴ®製品を差し上げます。

お買い上げの必要はありません。

禁止されていない限り、すべての皆様にご利用いただけます。