

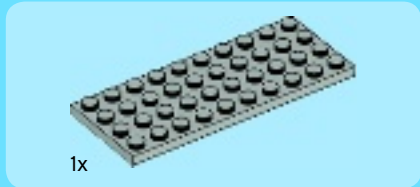

CREATOR

31003





1

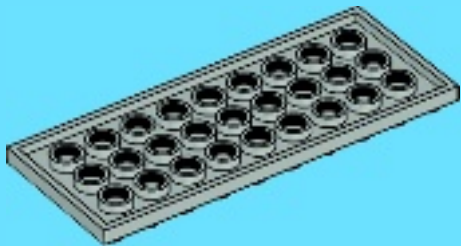

2



2x

2

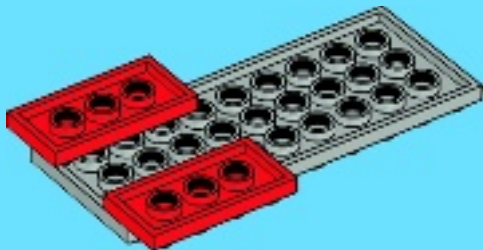



2x



2x

3



2x

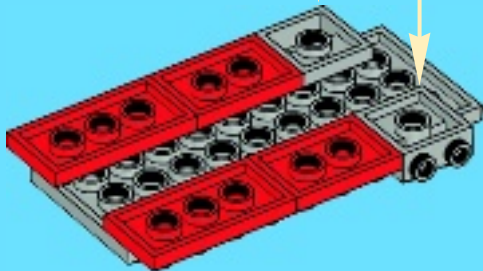

4



2x



2x

4





1x



2x

5



6



2x



2x

6

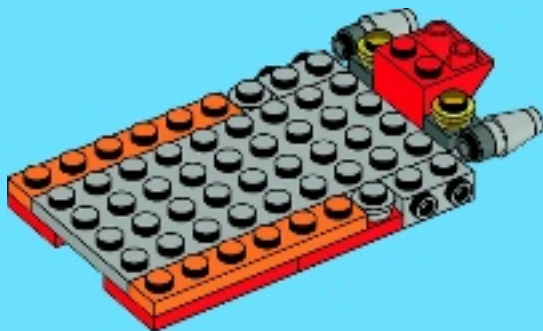



1x



2x

7



8



2x

8

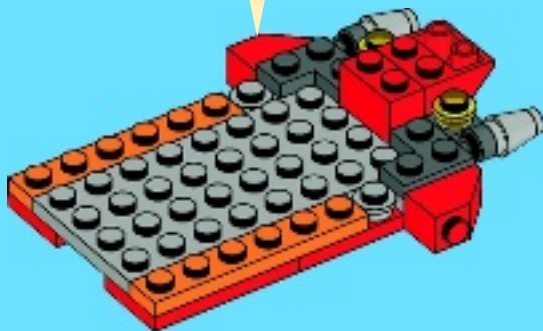



1x



2x

9

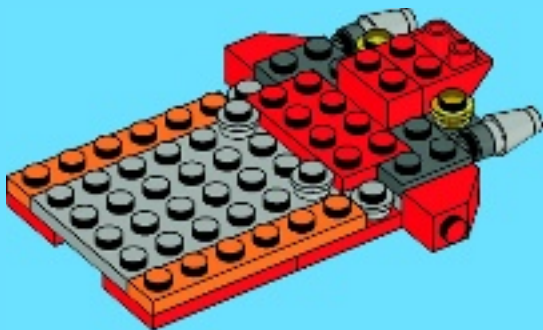



2x

10

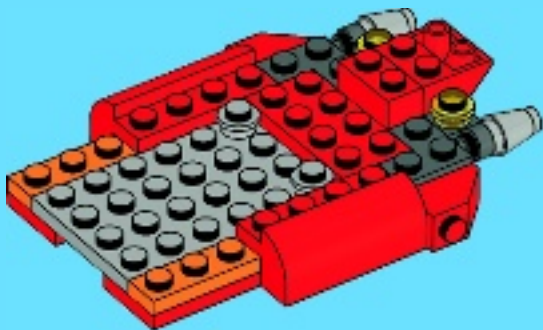



6x



1x

11

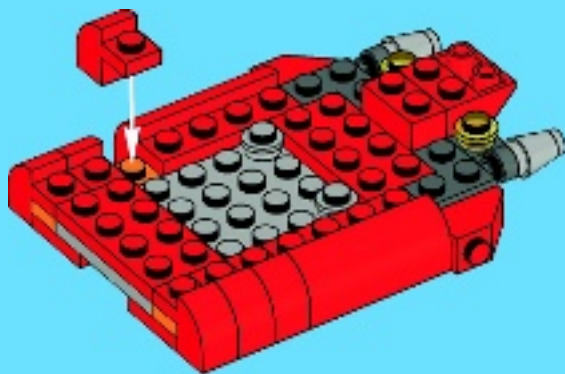

12



2x



2x

12



2x

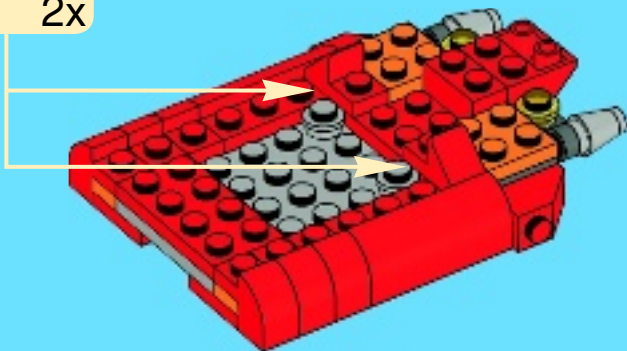



1x



4x



1x

13

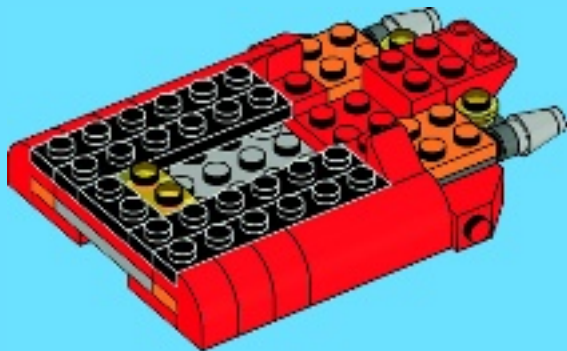



4x



2x

14





2x



1x

15

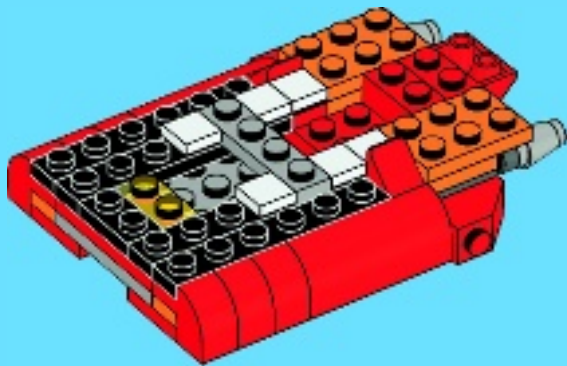

16



1x

16

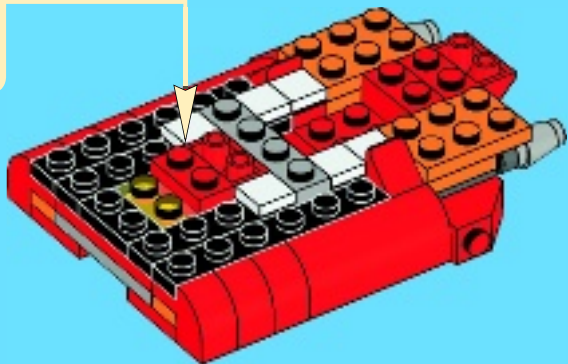



1x

17

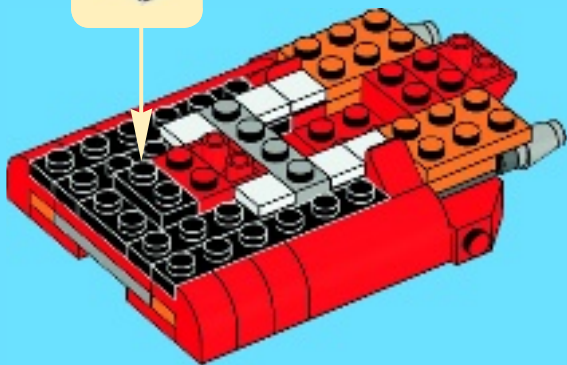

18

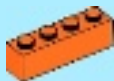

1x



2x

18

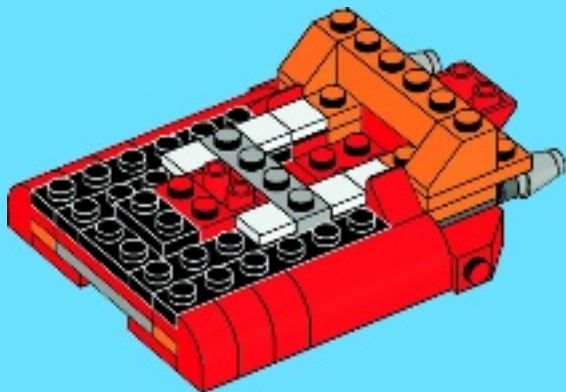



2x



2x



2x

19

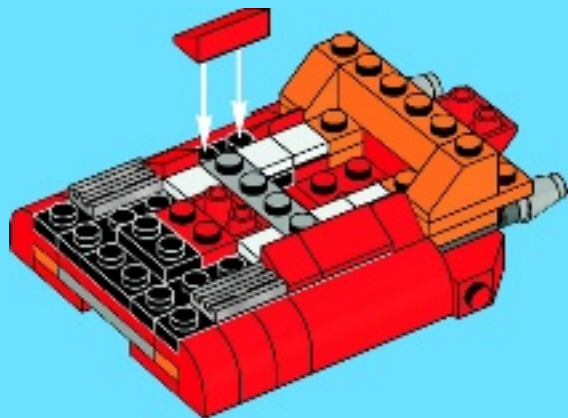



2x



2x



1x



1x



1x

20

1



2

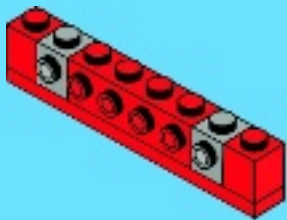

3

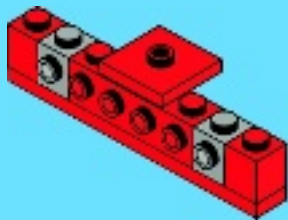

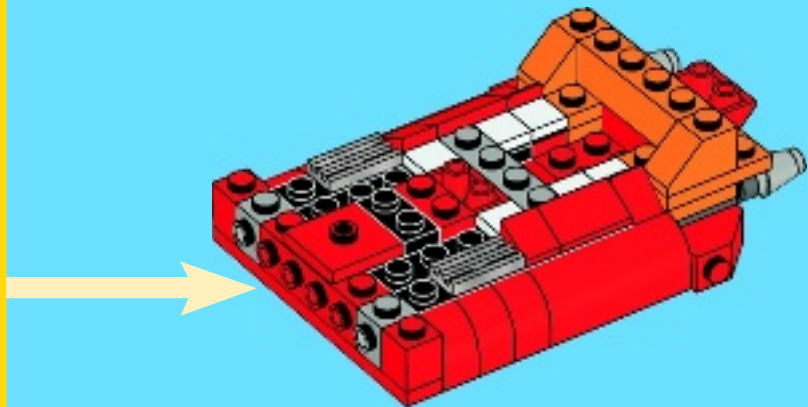



2x



2x



3x



1x

21

1

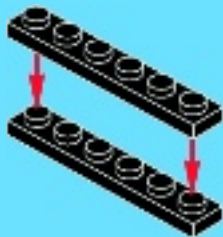

2

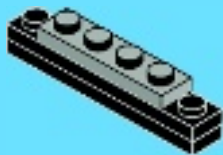

3

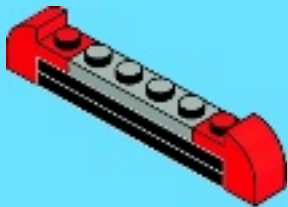

4

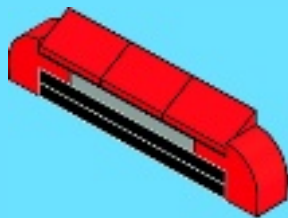

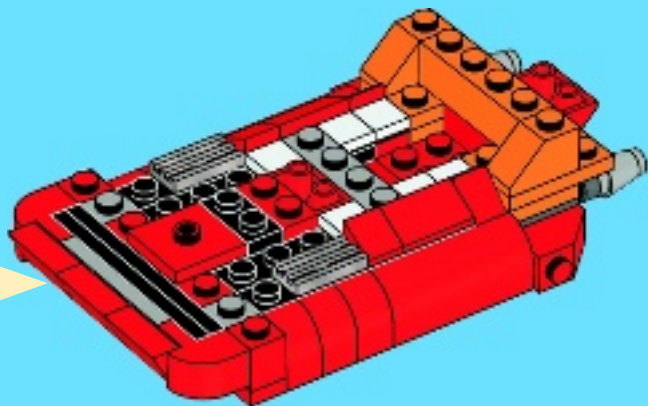



2x



2x

22

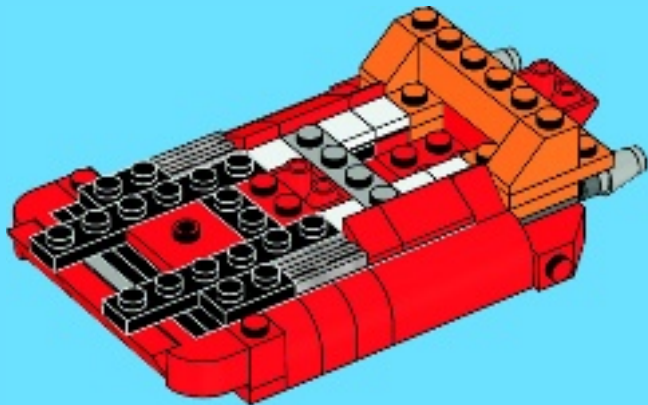

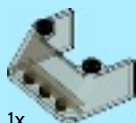

1x



2x

23

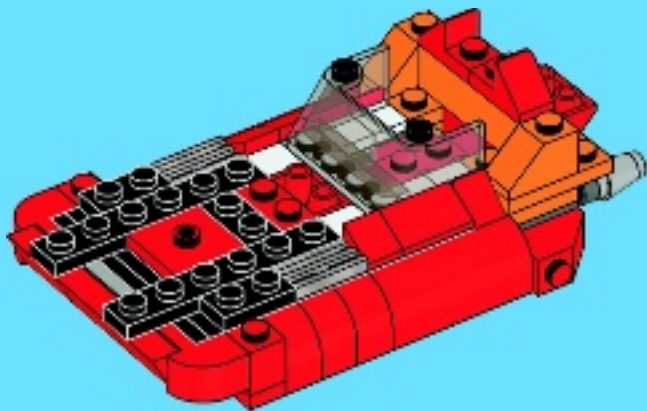



2x



2x

24

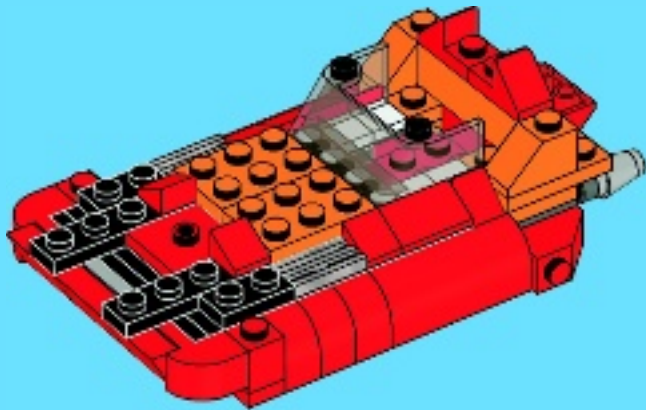



1x



2x

25

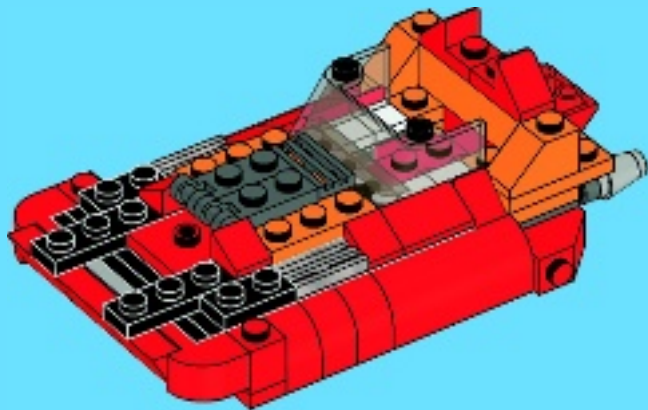



1x

26

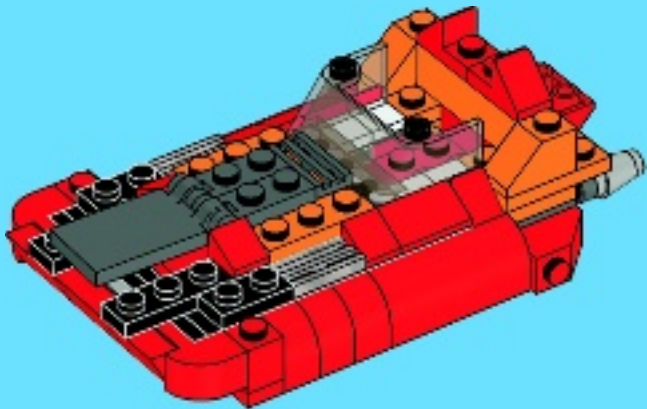



1x

1

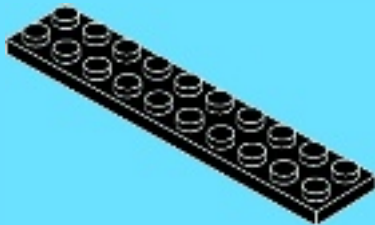



2x



2x



1x

2

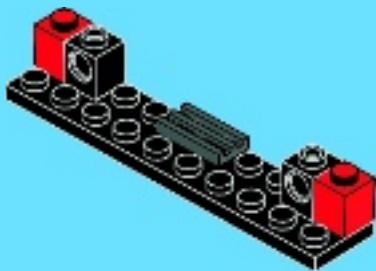



2x



2x

3

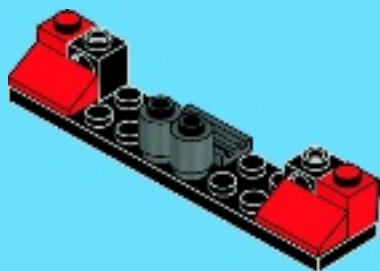



2x

4

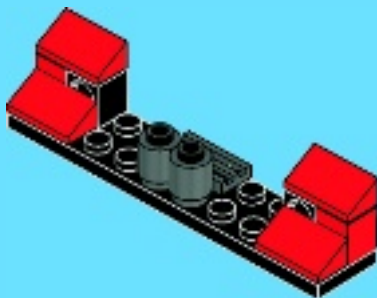

27

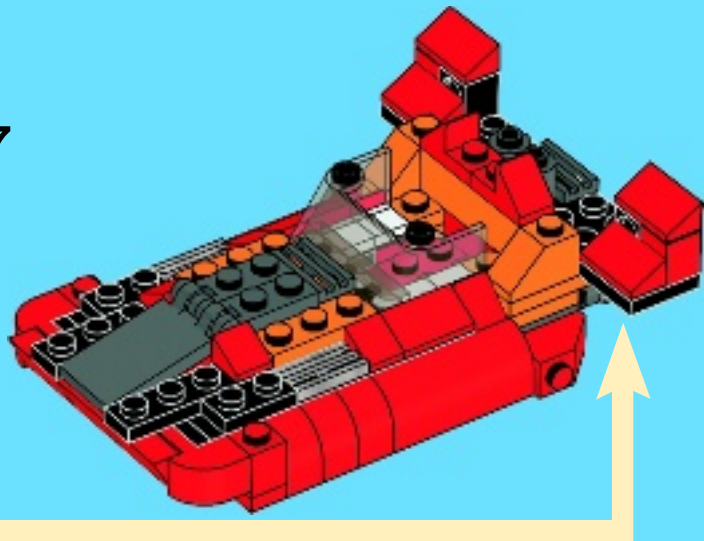



1x

28

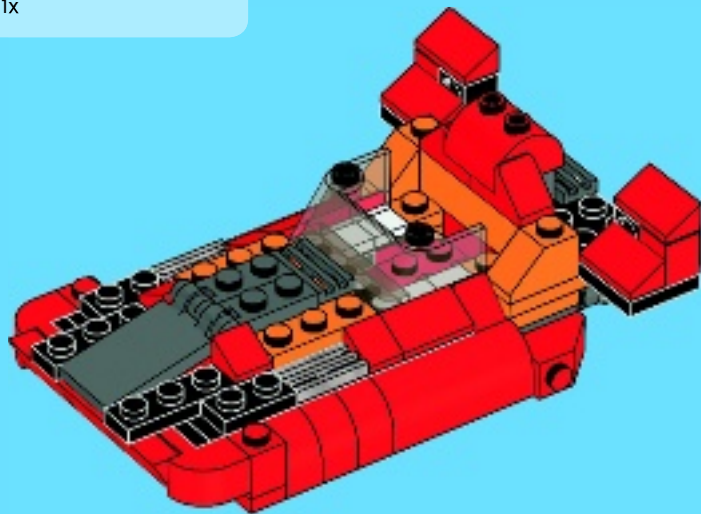



2x



29

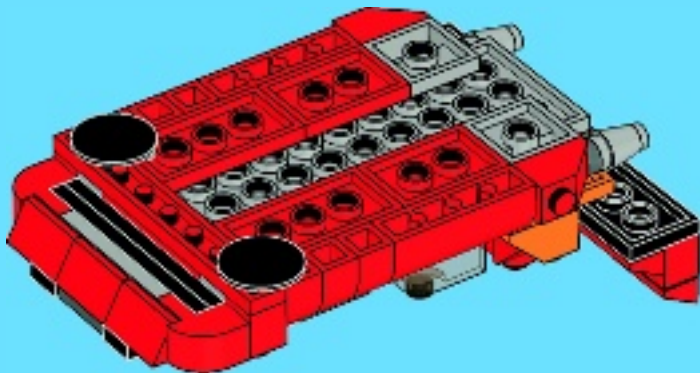



2x



2x



2x



2x

30

1



2

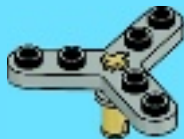

2x

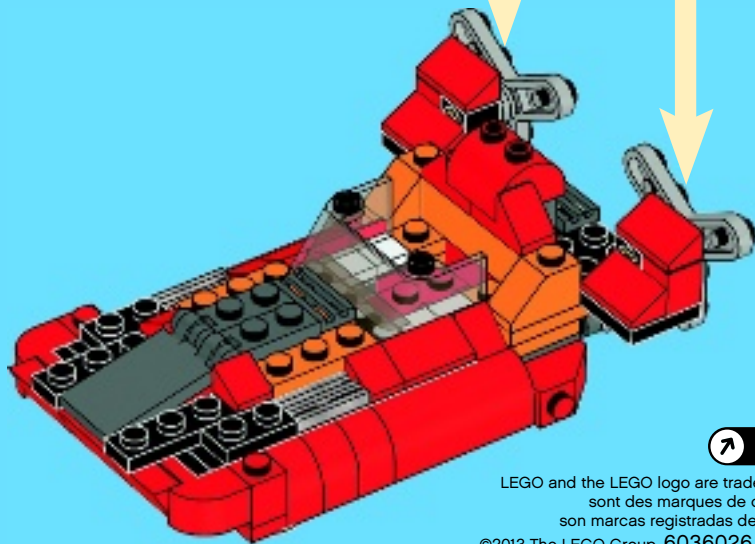

LEGO and the LEGO logo are trademarks of the/
sont des marques de commerce de/
son marcas registradas de LEGO Group.
©2013 The LEGO Group. 6036026 / 6036028