

77

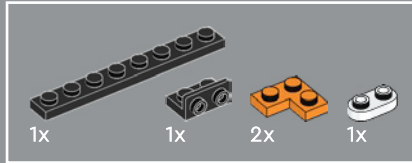

78

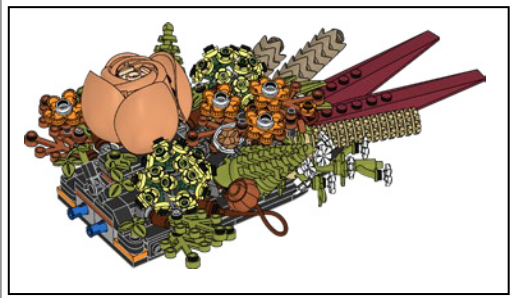

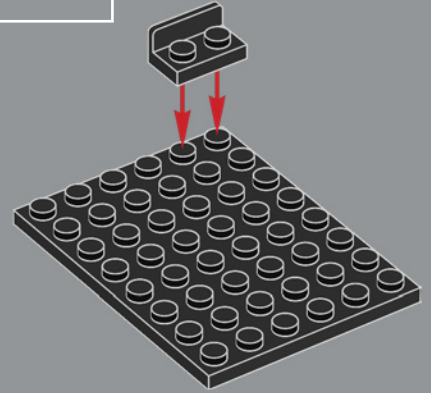
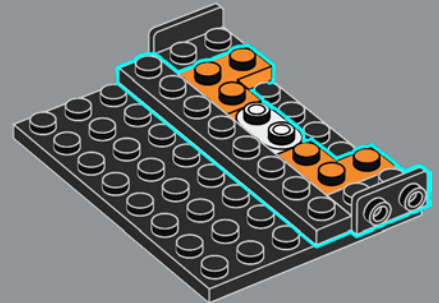
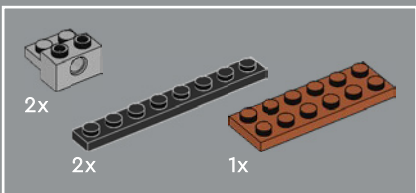

79

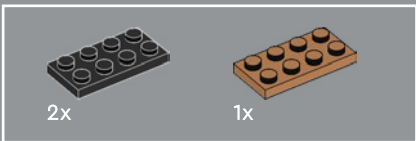
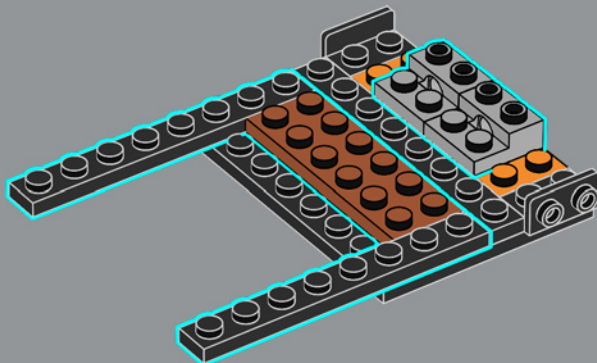

80

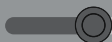
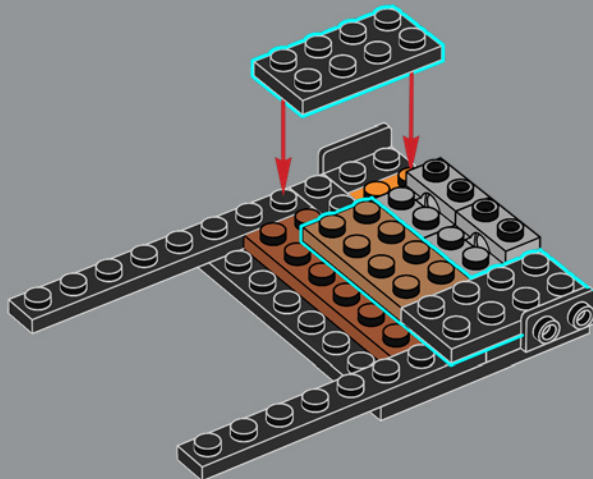



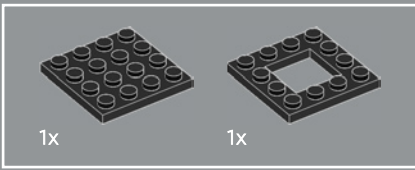

81

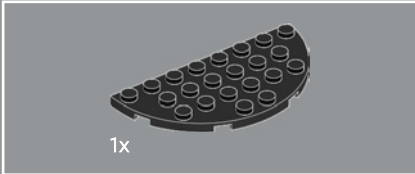
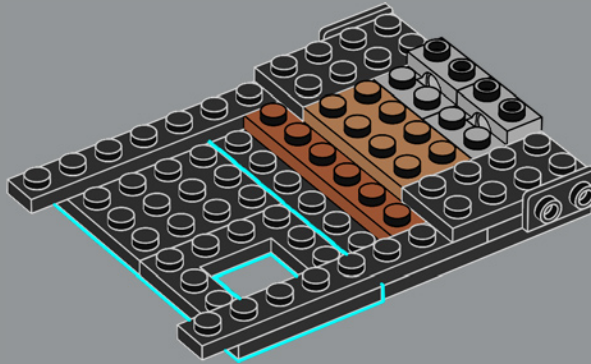

82

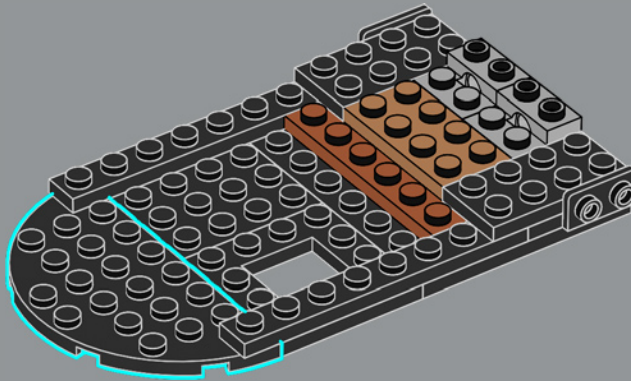

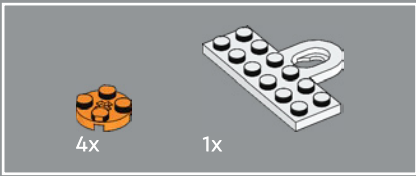

83

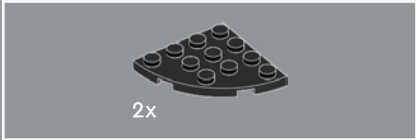
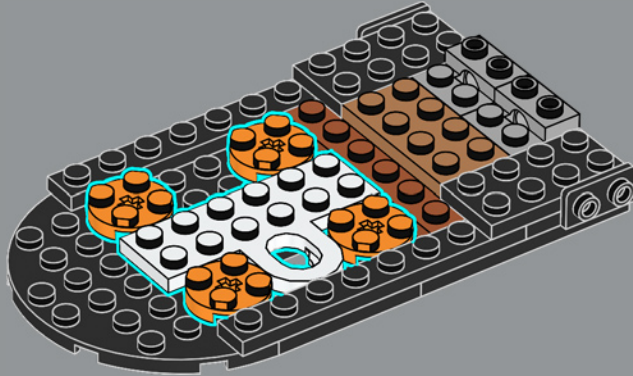

84

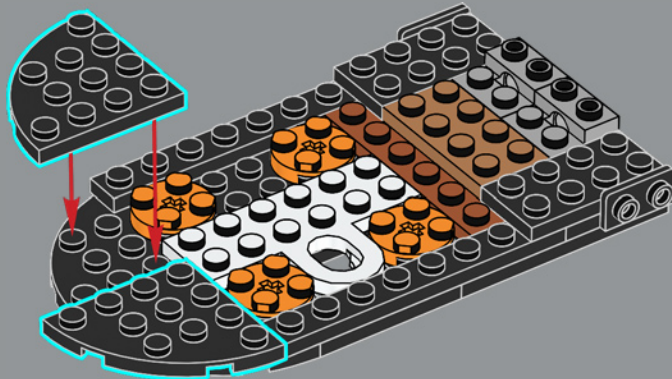

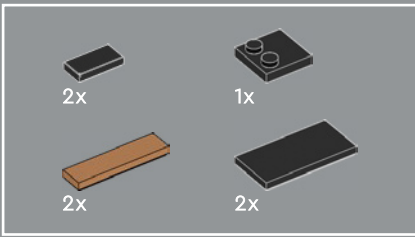

85

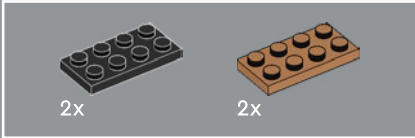
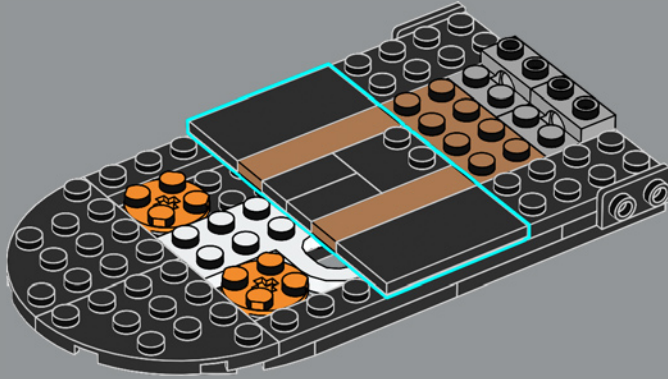

86

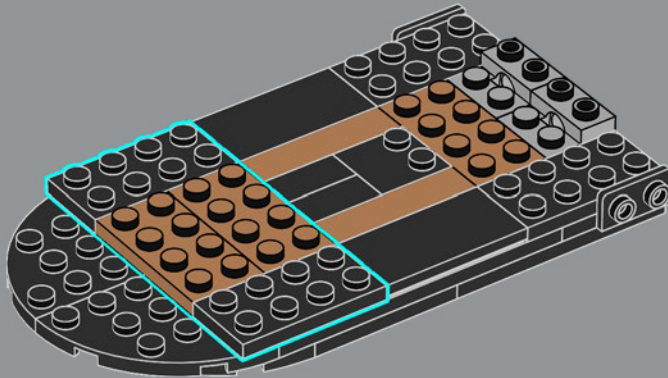

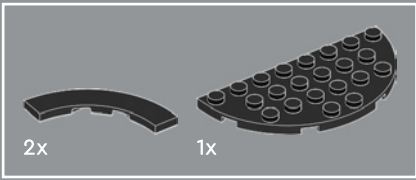

87

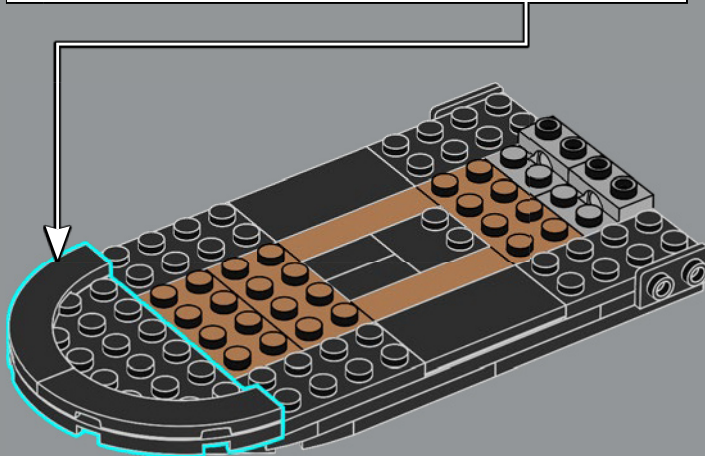
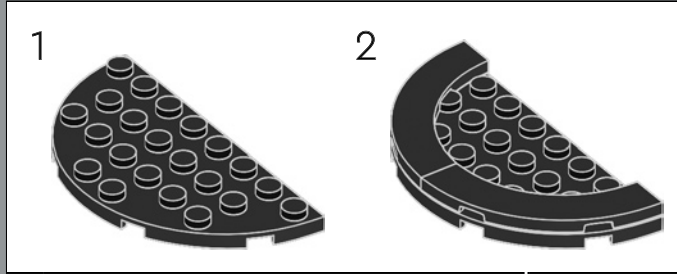

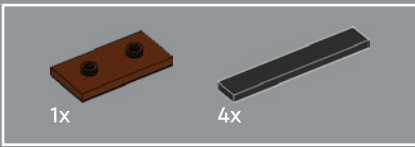

88

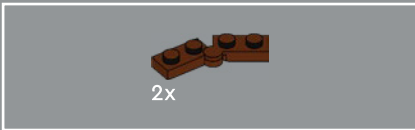
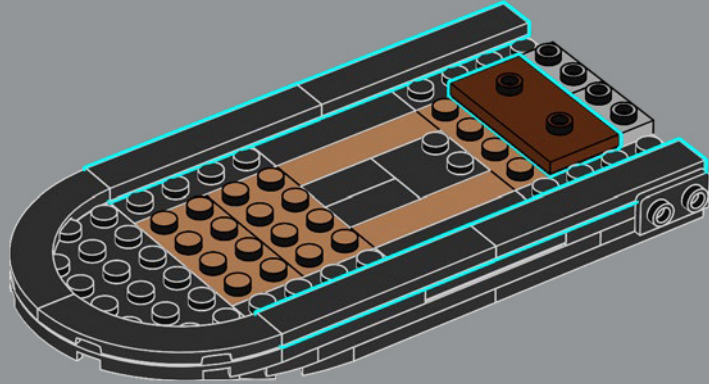

89

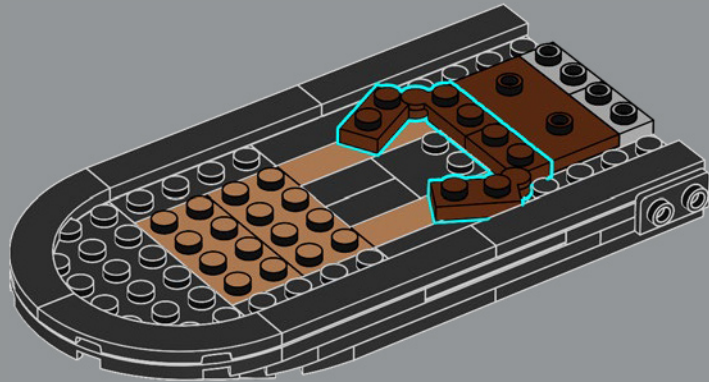



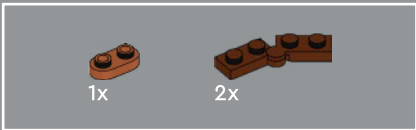

90

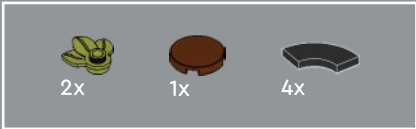
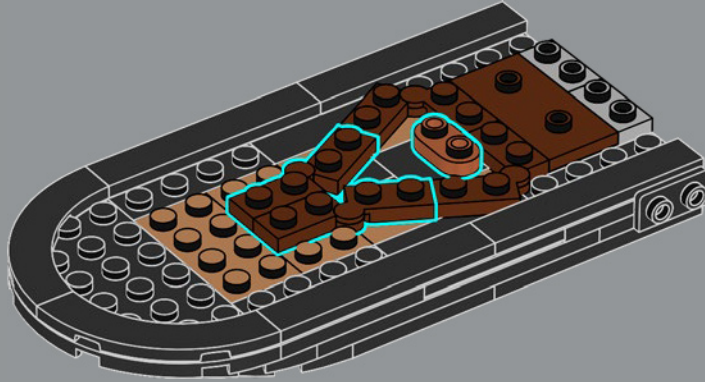

91

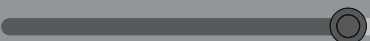

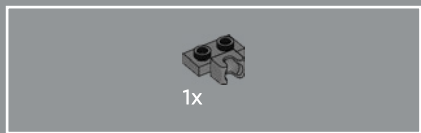

93

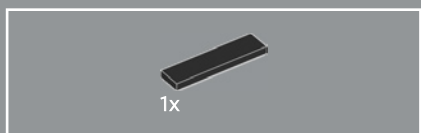
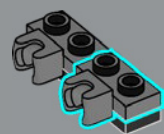

94

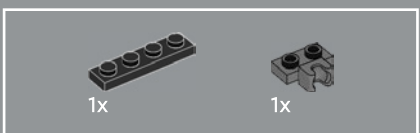
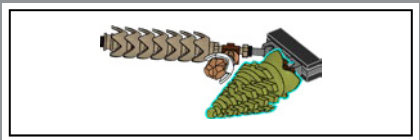
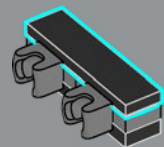

92

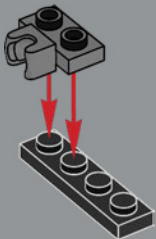



95

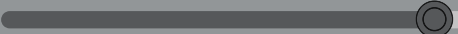
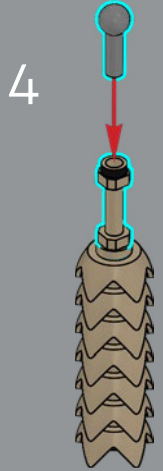
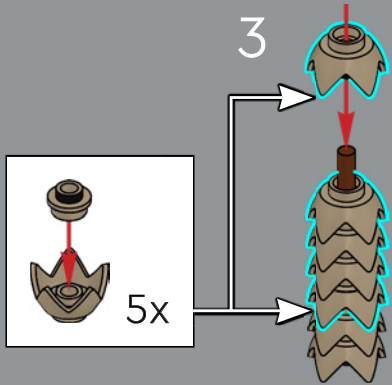
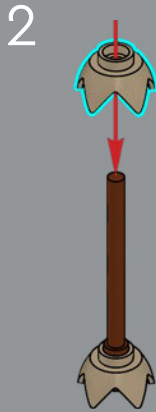
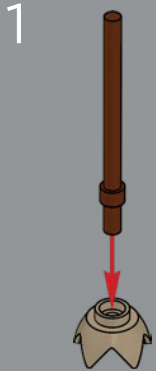



5

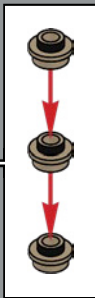

1x



1x



1x



1x

96

1



2



3

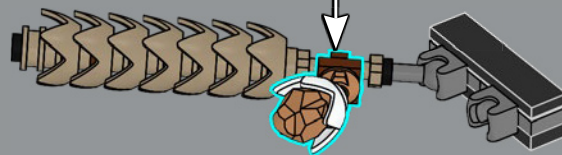

Les couronnes imbriquées utilisées pour former les tiges de blé donnent à la plante son aspect ondulé.

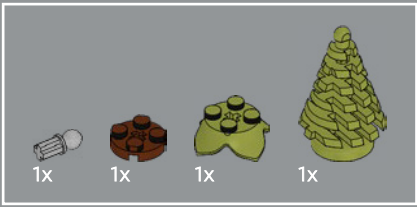

97

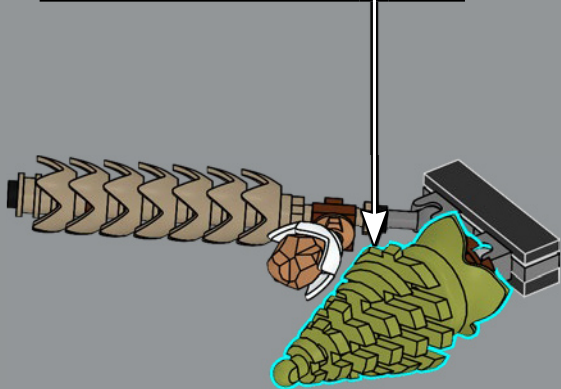
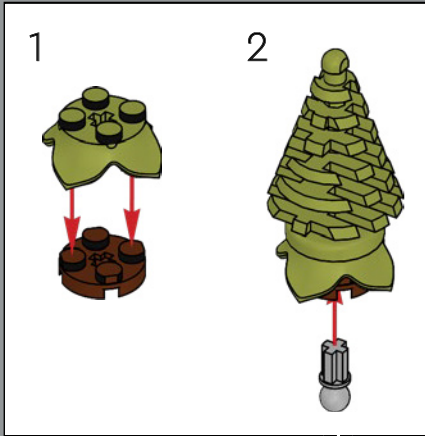

98

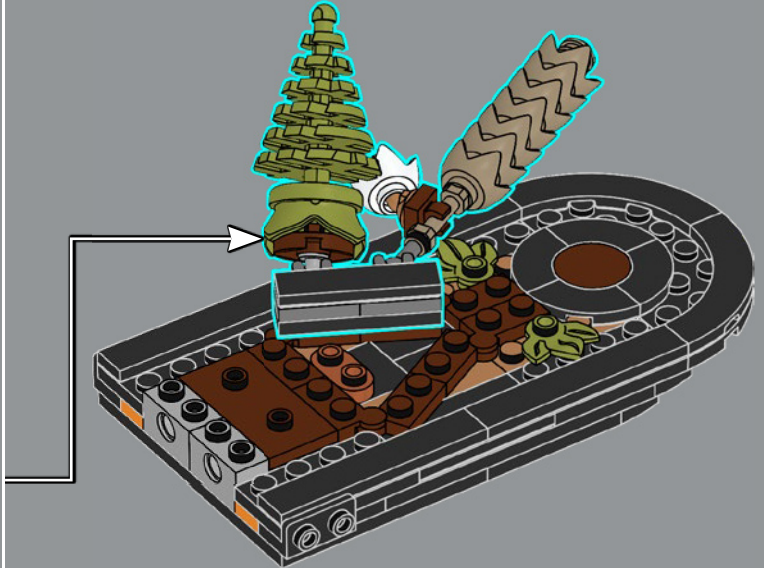



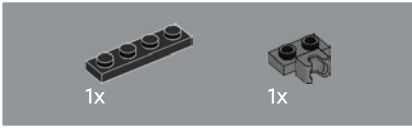
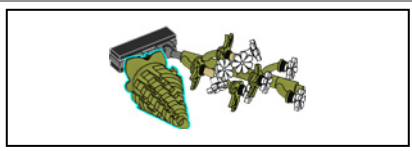

99

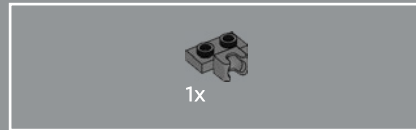
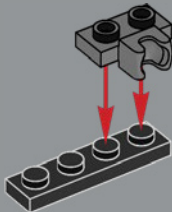

100

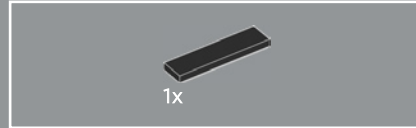
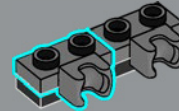

101

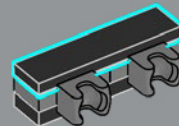

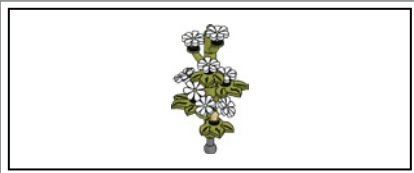

102



103

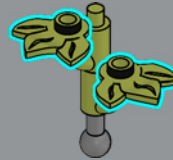

104

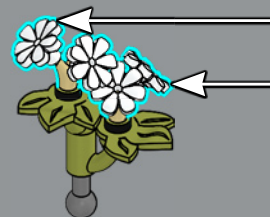
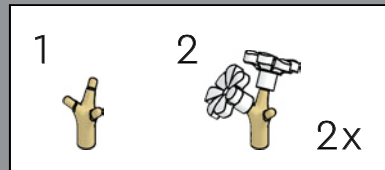

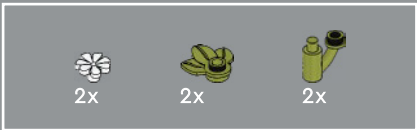

105

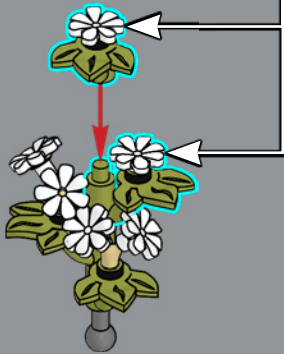
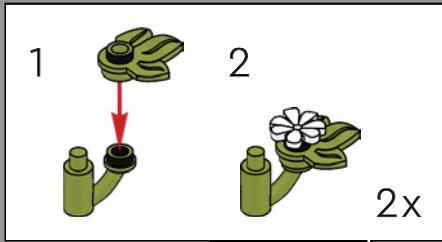

106

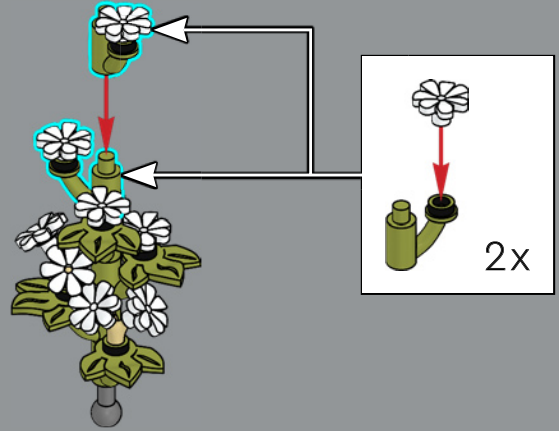

107

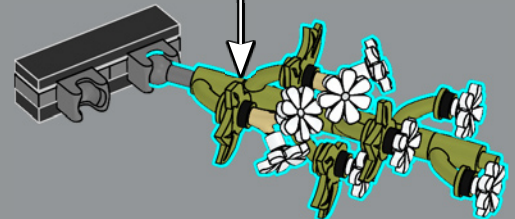

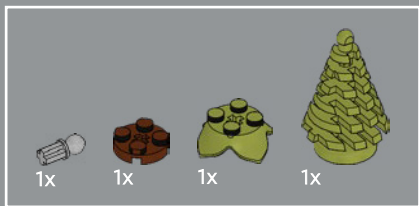

108

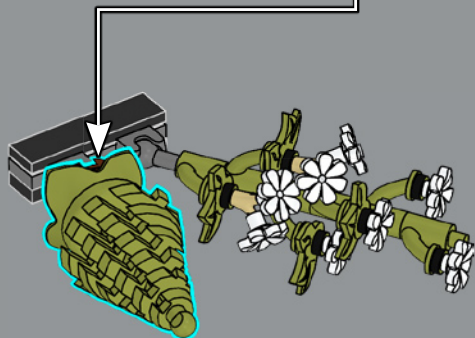
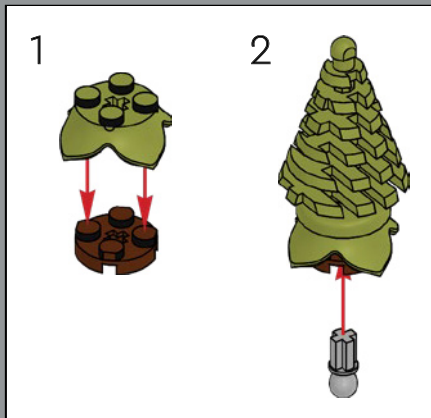

109

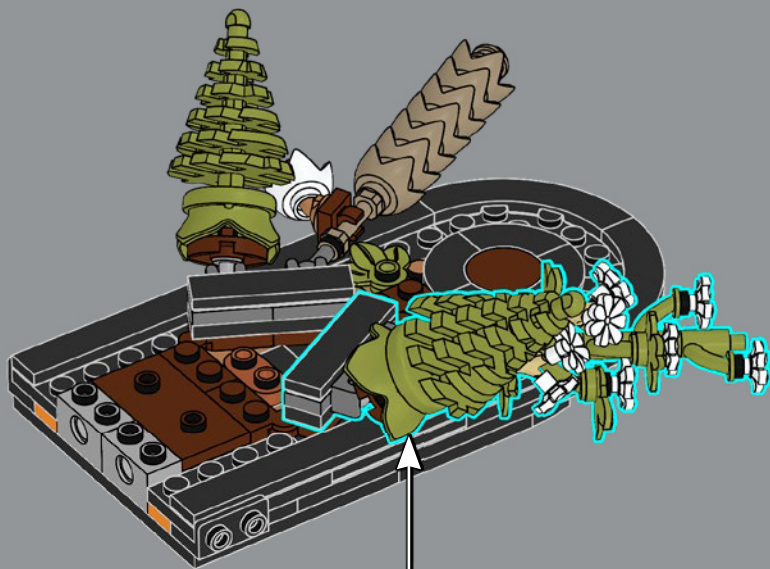

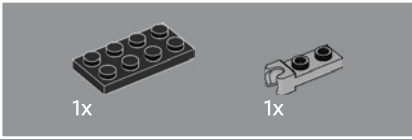
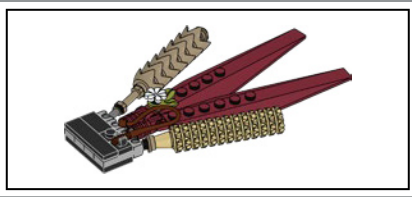

1x

1x

110

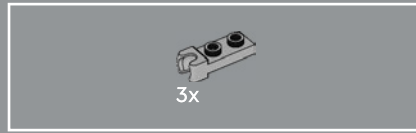
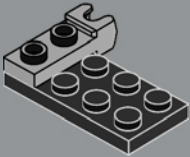

3x

111

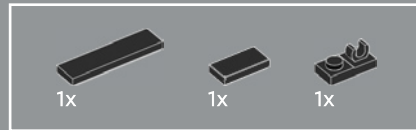
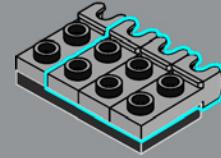

1x

1x

1x

112

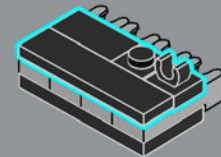



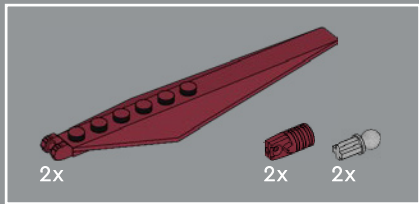

113

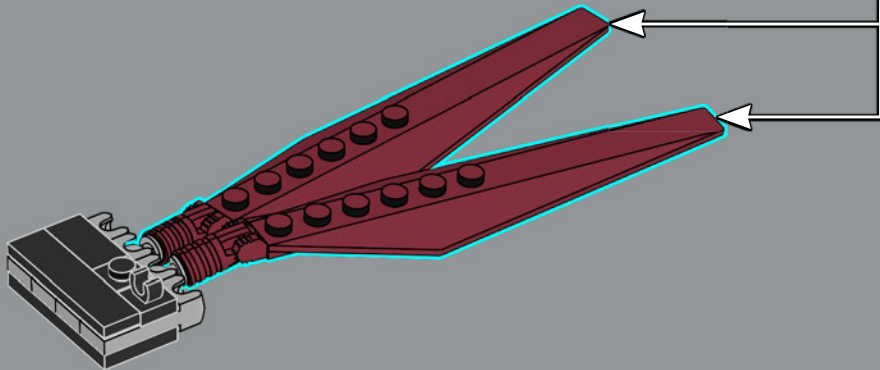
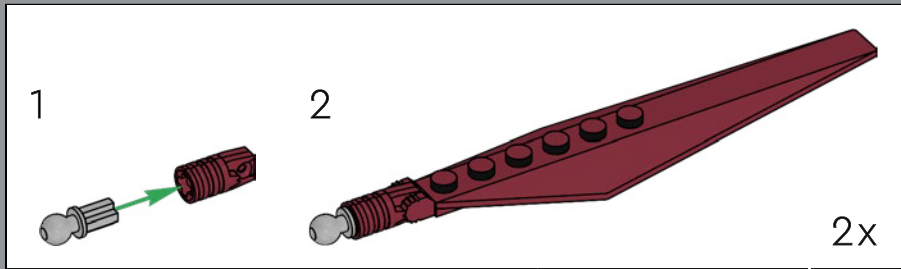

114

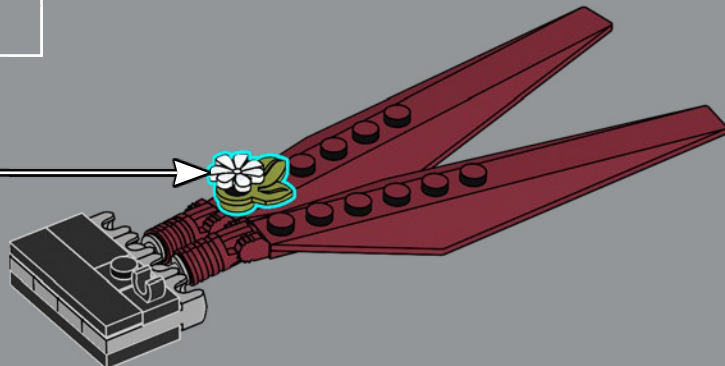
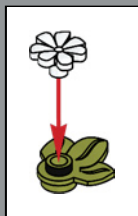



115

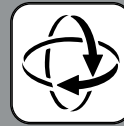
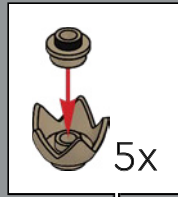
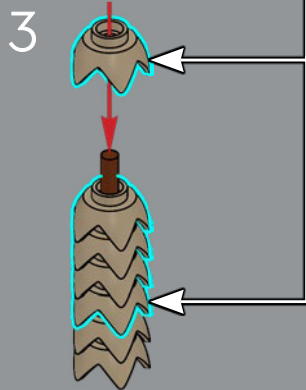
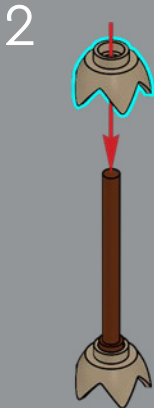
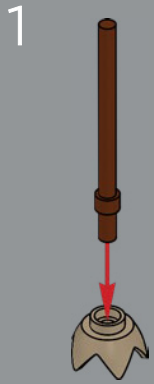

5

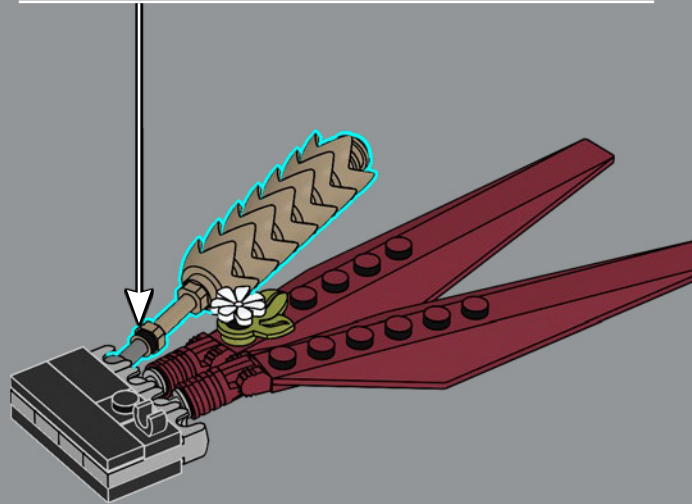
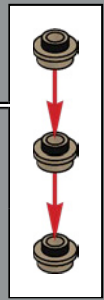

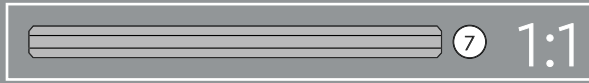
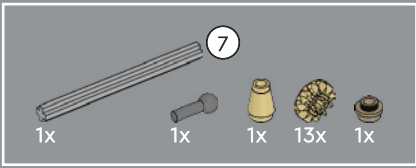

116

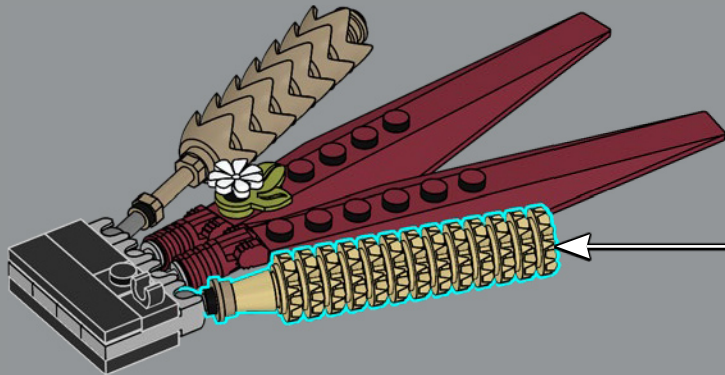
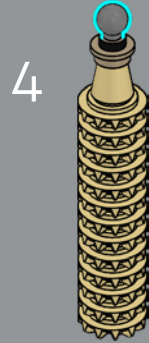
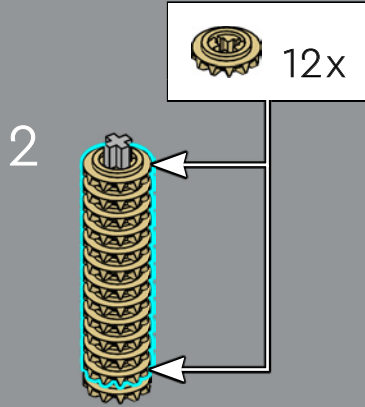



117

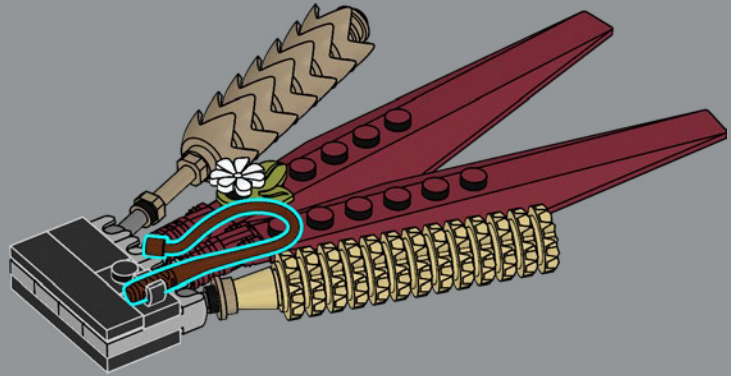

118

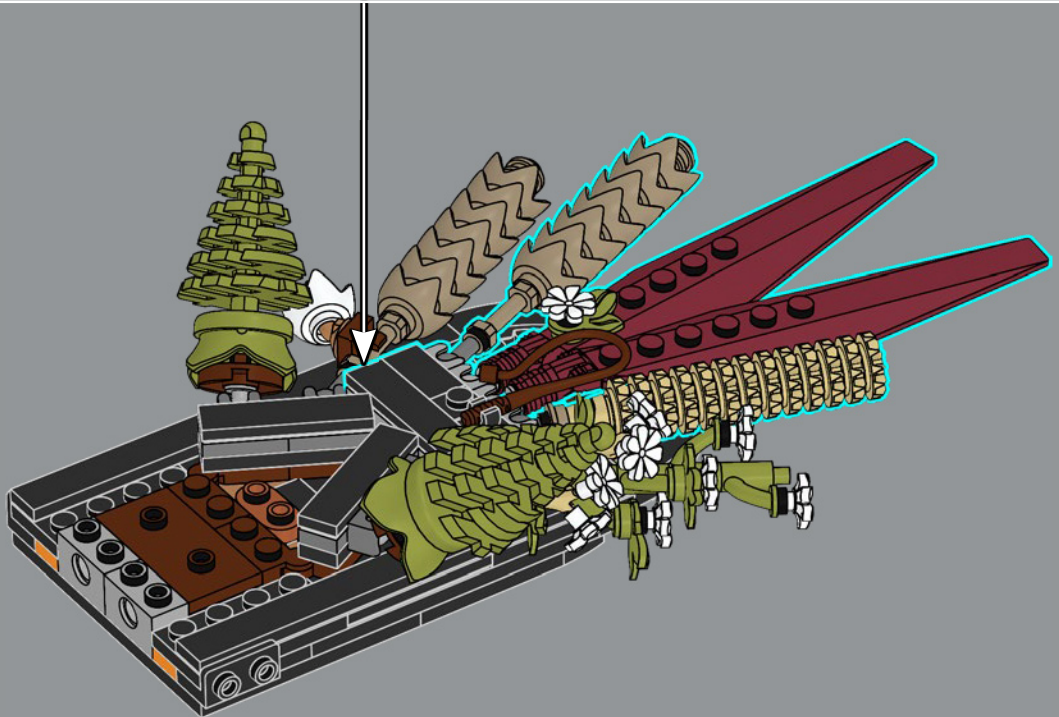

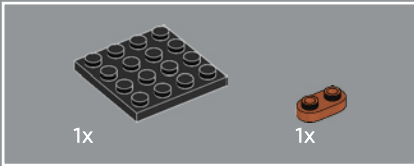
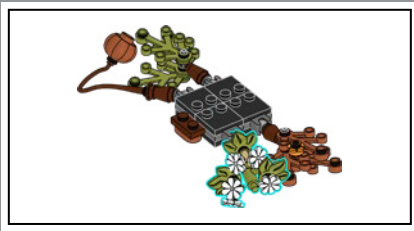

119

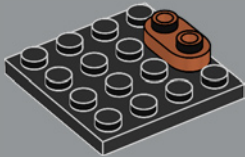

120

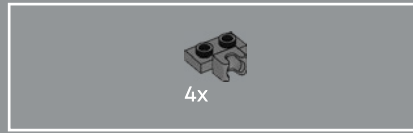
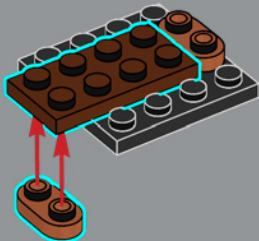

121



4x

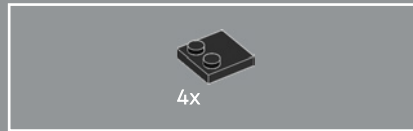
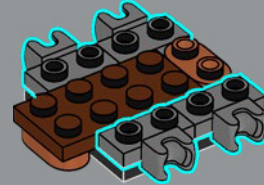

122



4x

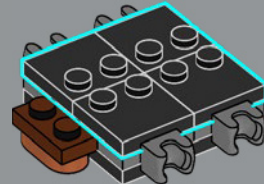



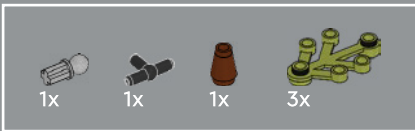

123

1

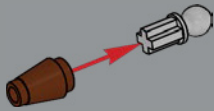

2

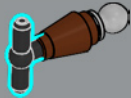

3

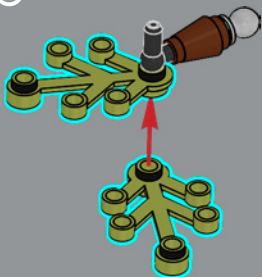

4

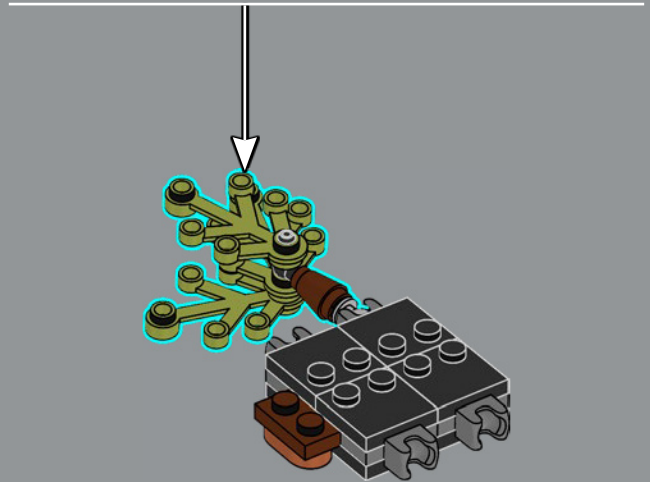
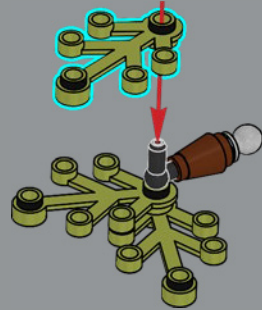



124

1

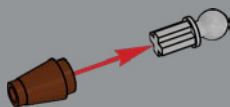

2

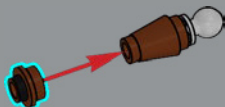

3

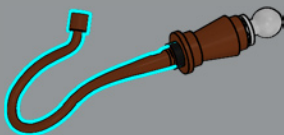

4

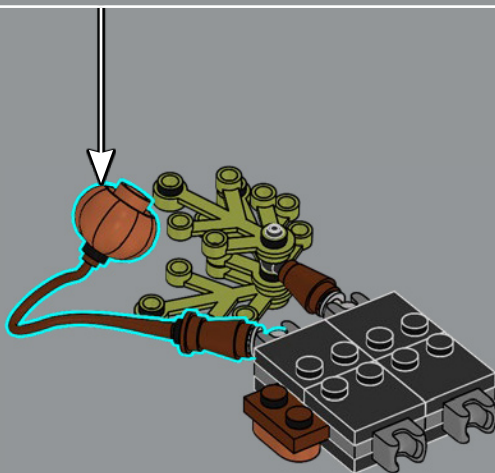
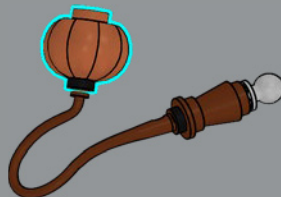

L'Alkékonge est réalisée avec un élément LEGO® généralement utilisé pour représenter des légumes (comme des citrouilles ou des lanternes), et avec un fouet brun souple.





125

1

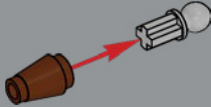

2

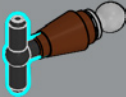

3

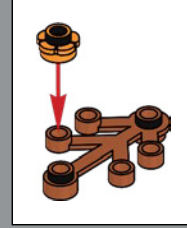
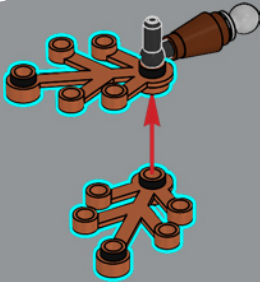

4

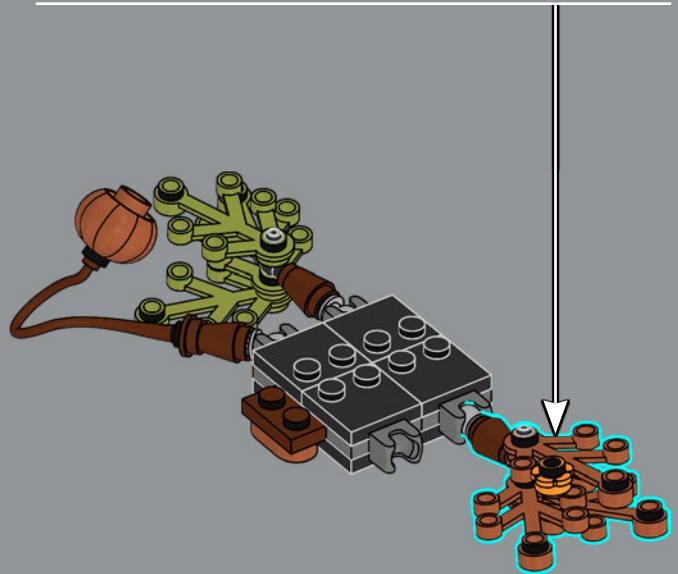
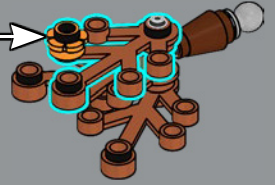

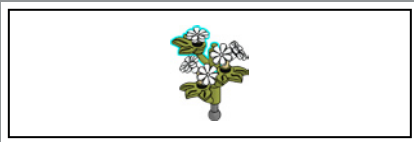

126

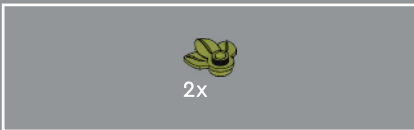

127

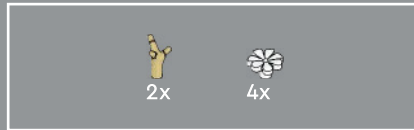
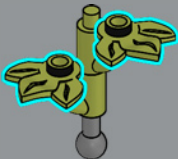

128

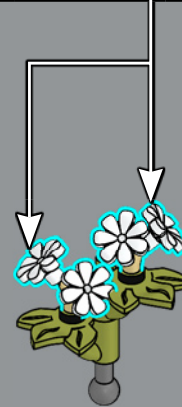
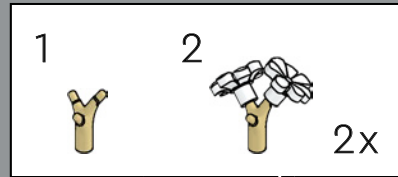

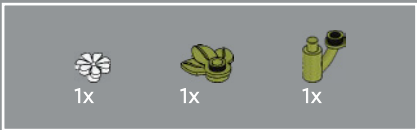

129

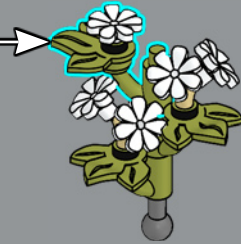
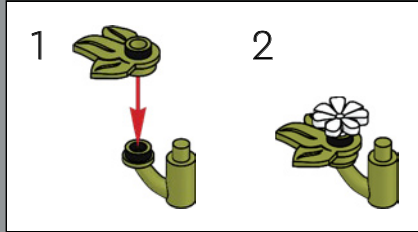

130

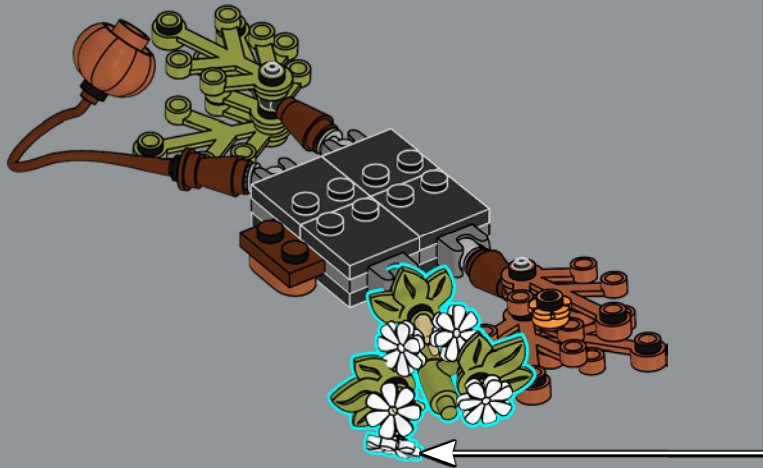

131

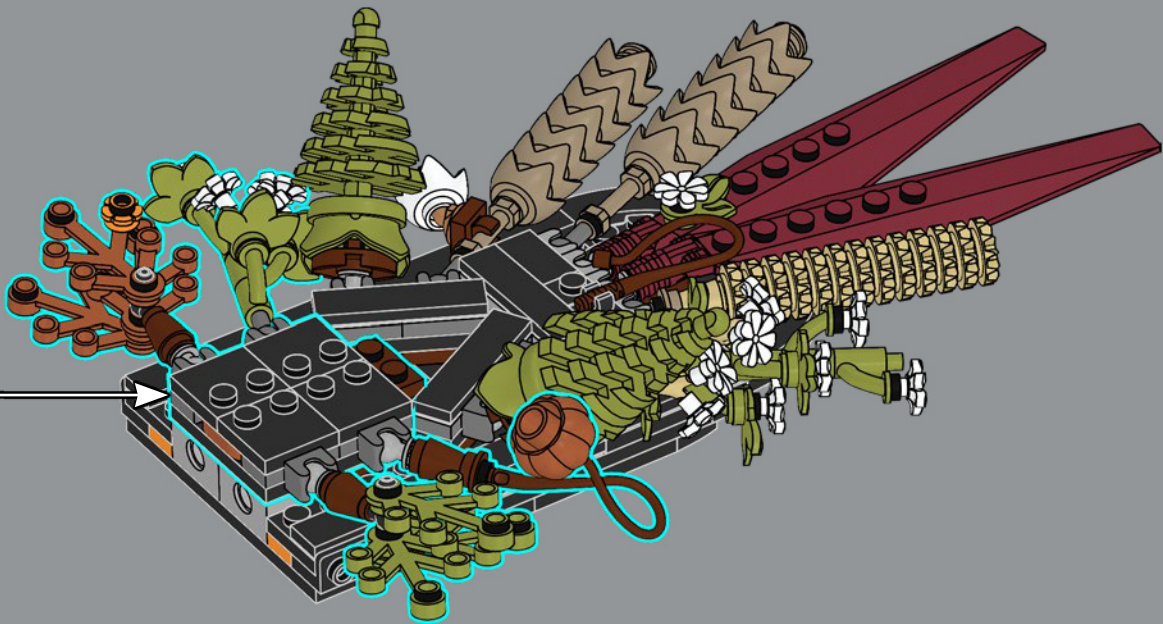

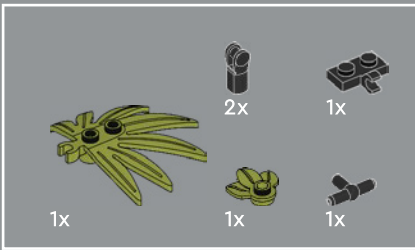

132

1

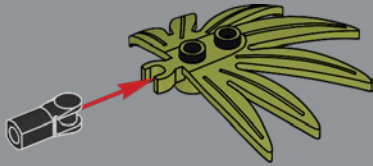

2

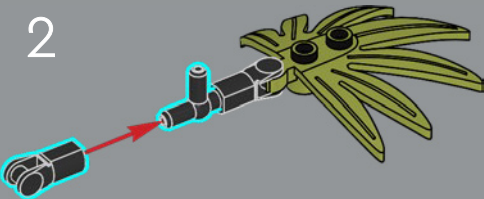

3

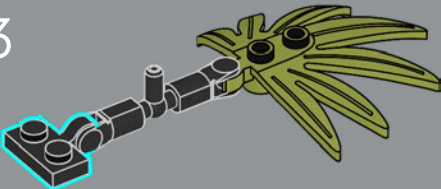

4

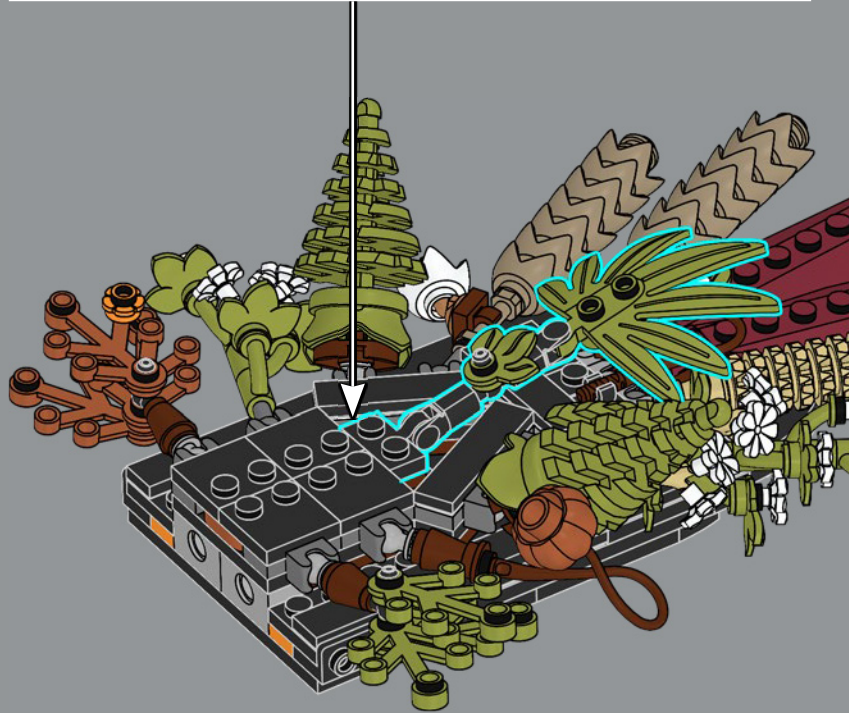
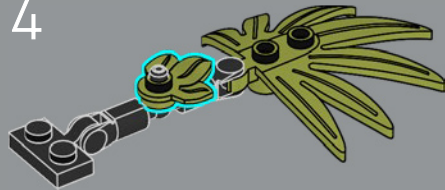



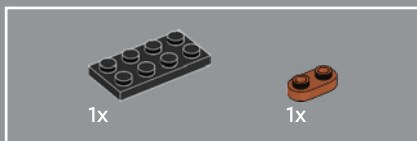
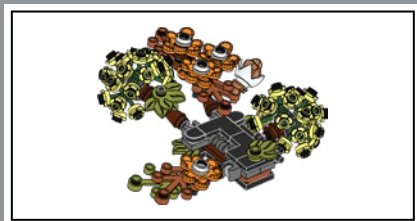

133

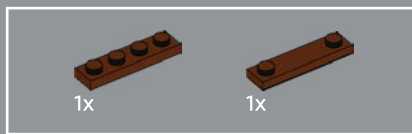
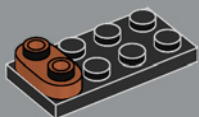

134

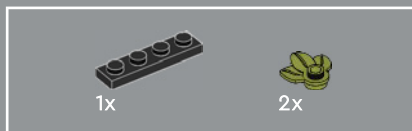
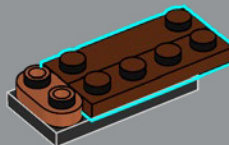

135

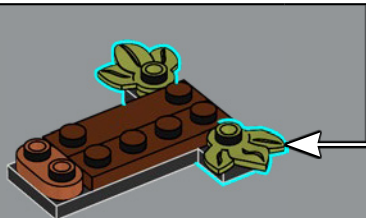
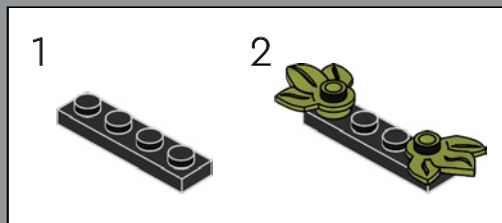

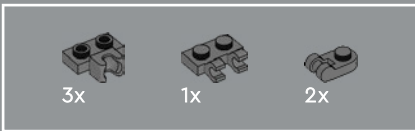

136

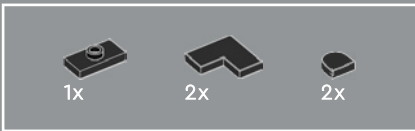
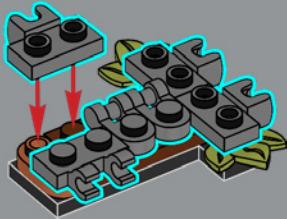

137

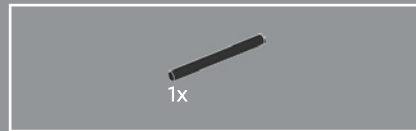
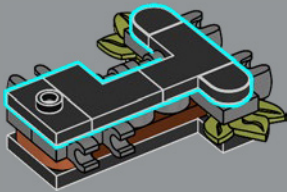

138

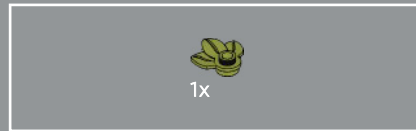
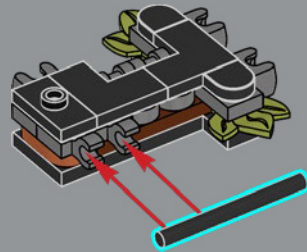

139

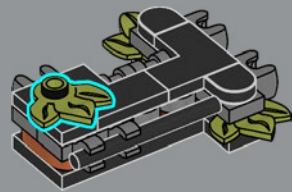

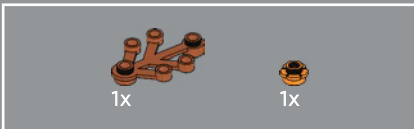
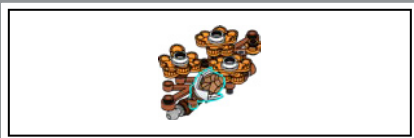

140

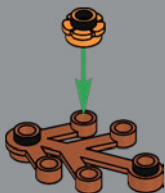

141

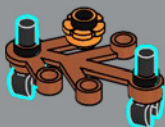

142

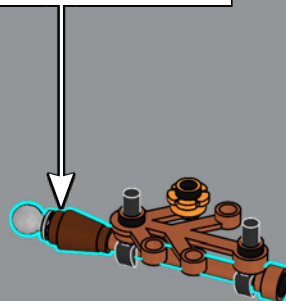
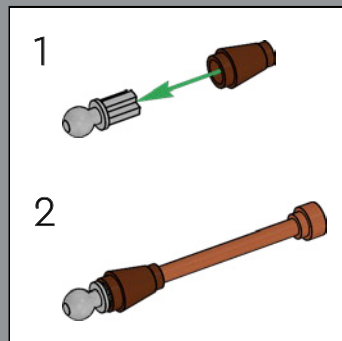

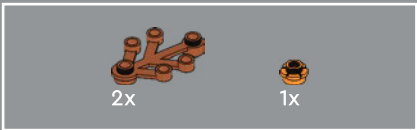

143

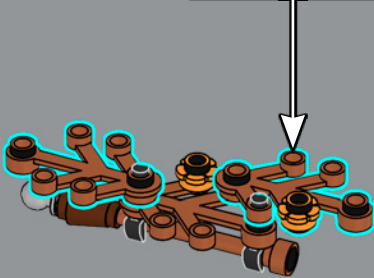
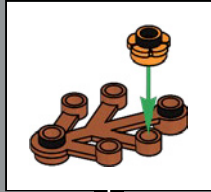

144

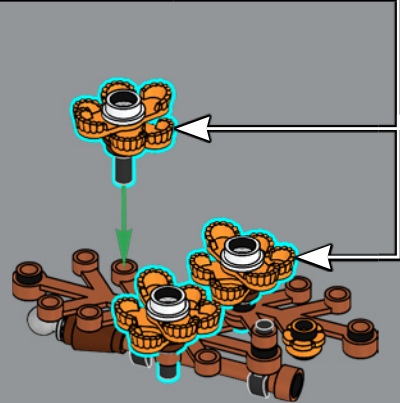
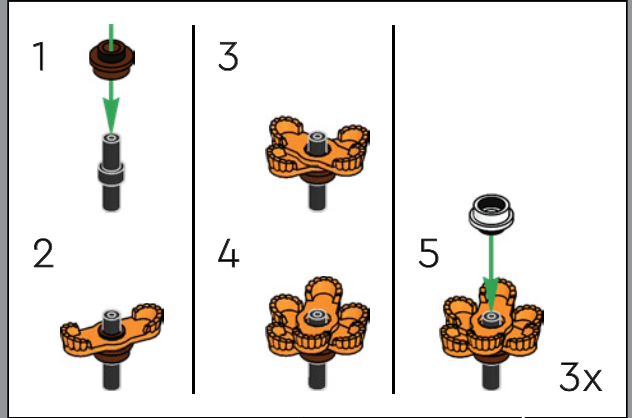



1x



1x



1x

145

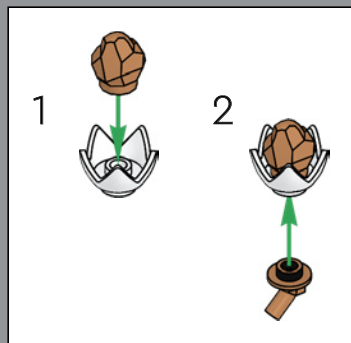

Les têtes de Marguerite séchées sont construites avec une couronne blanche et une pierre rare, utilisée pour la première fois pour représenter une pépite d'or.

146

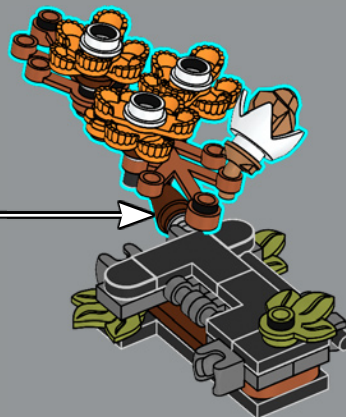

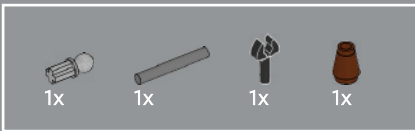

147

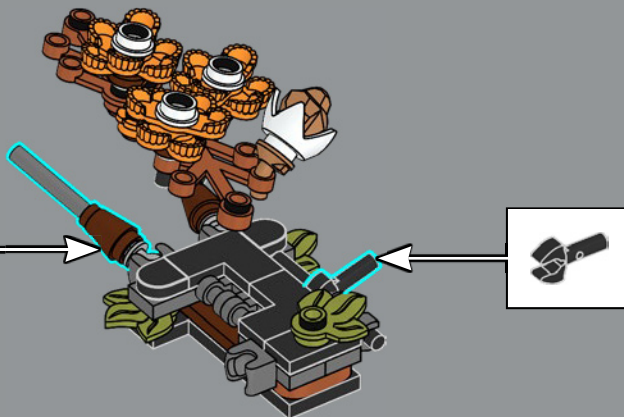
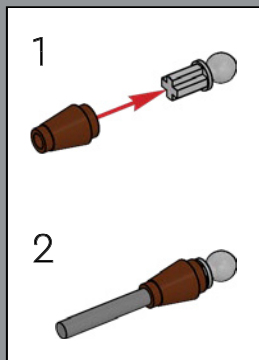



148

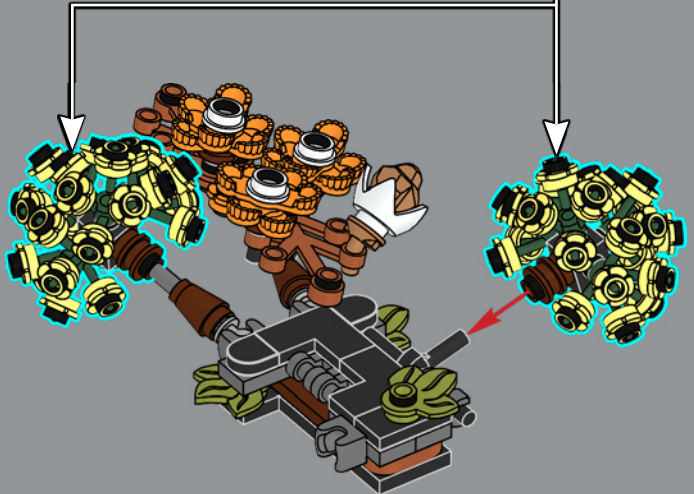
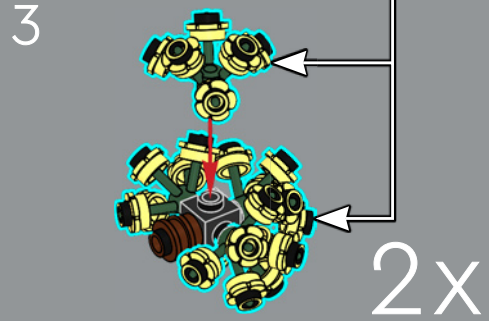
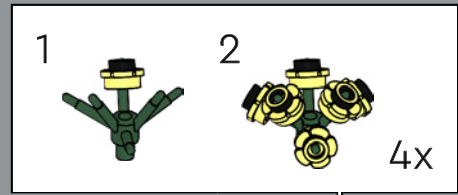
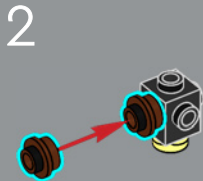
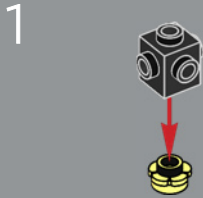





1x



2x

149

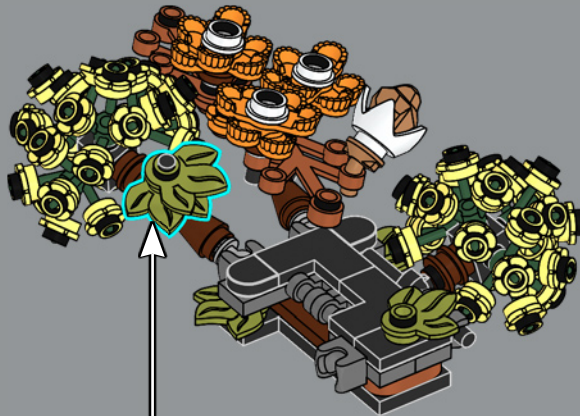

1

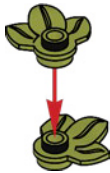

2



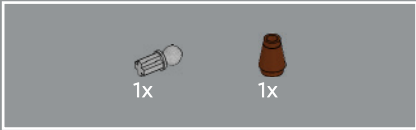

150

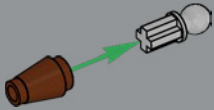

151

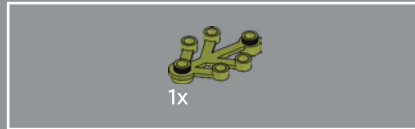
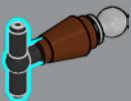

152

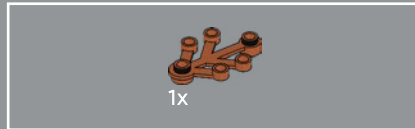
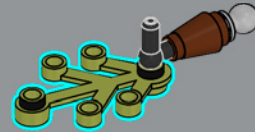

153

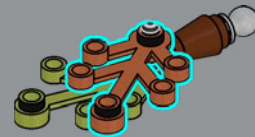

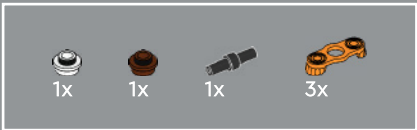

154

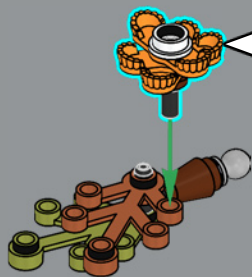
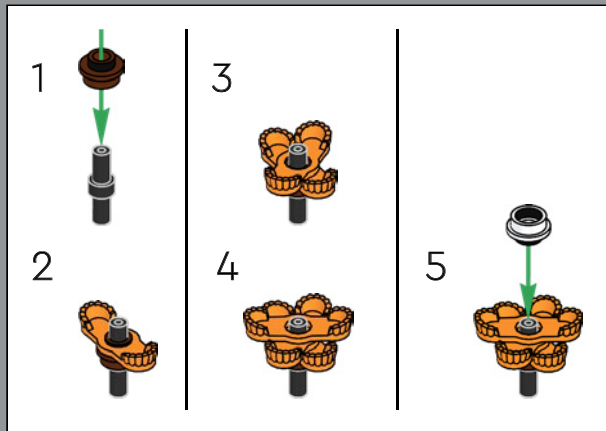

155

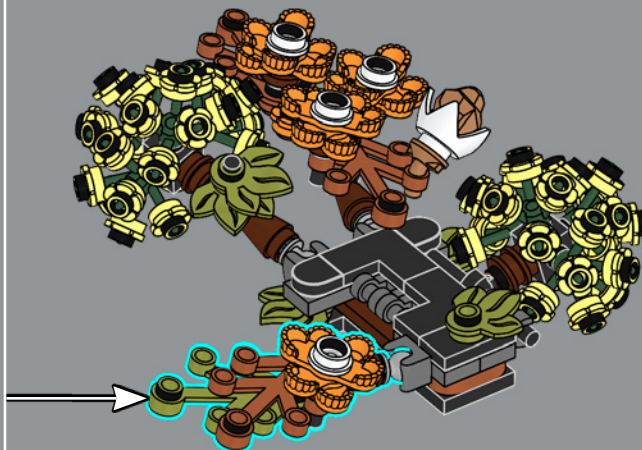

156

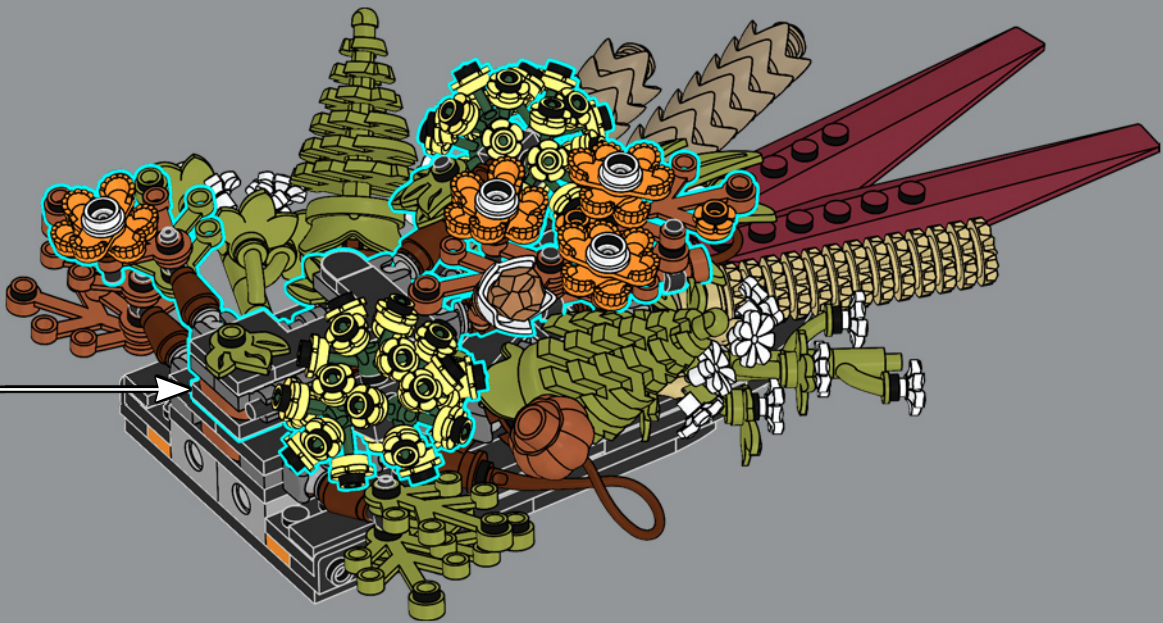

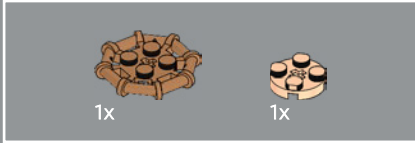
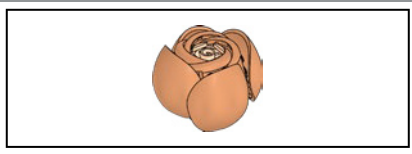

157

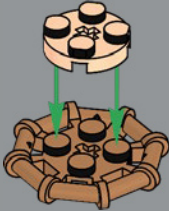

158



159

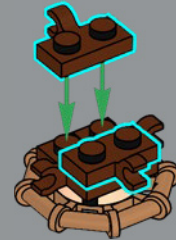

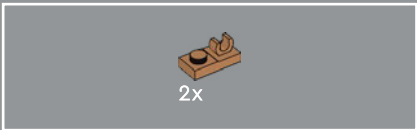

160

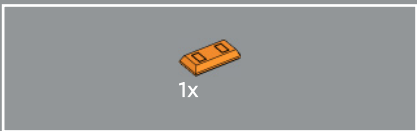
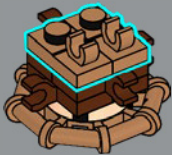

161



162

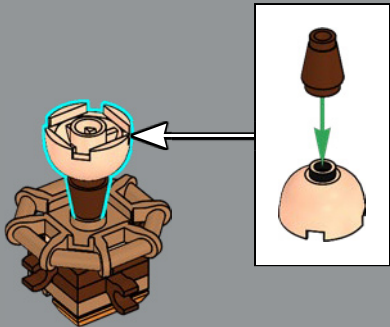

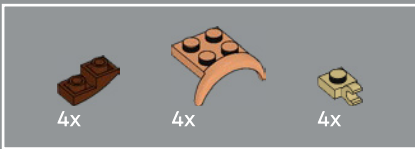

163

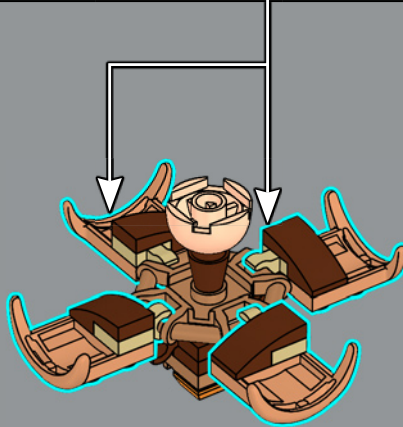
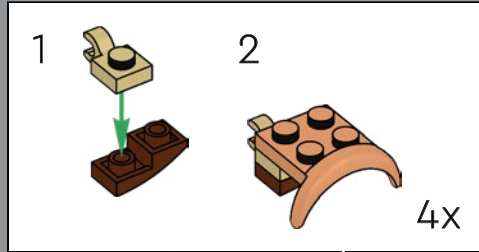



164

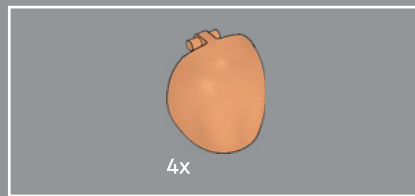
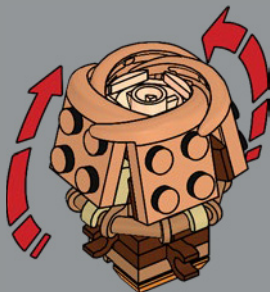

165

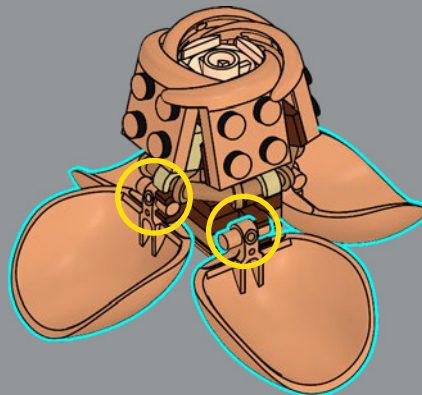

166

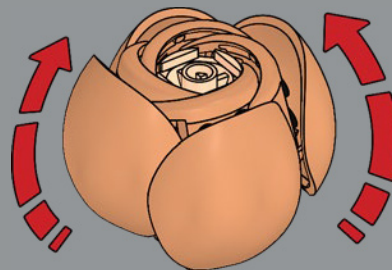



La construction complexe de la rose fait appel à de nouveaux éléments garde-boue pour les pétales internes et à un nouvel élément coquillage pour les pétales externes.

167

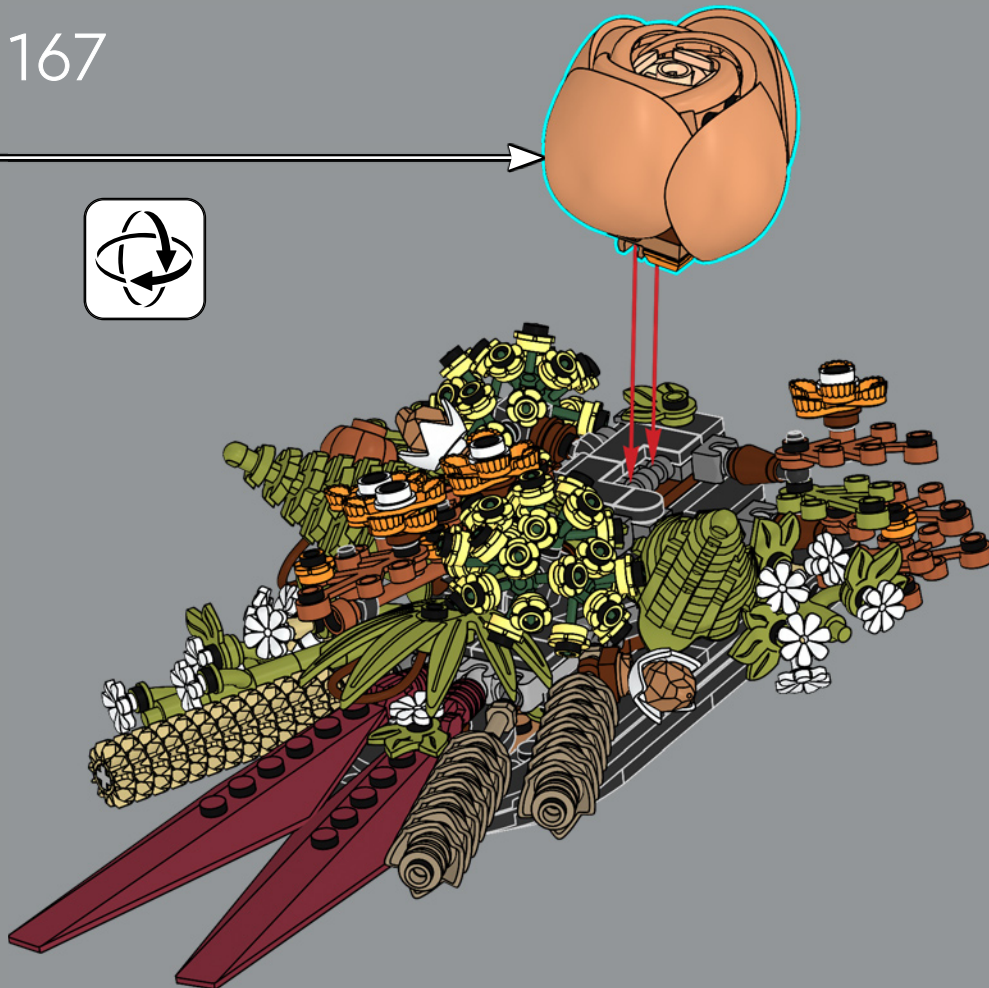



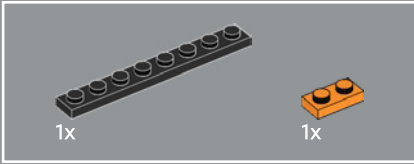

168

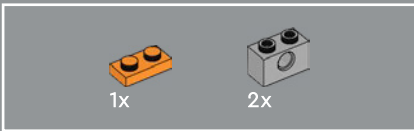
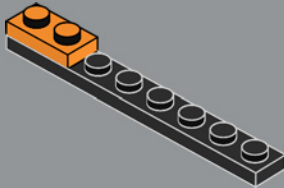

169

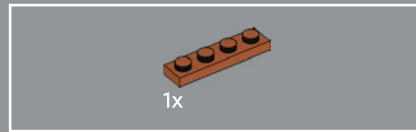
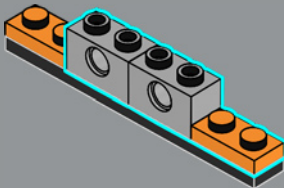

170

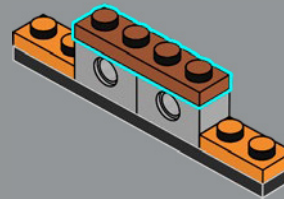

171

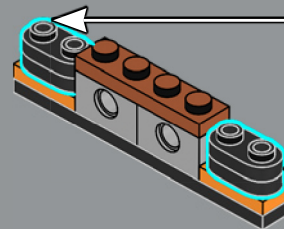
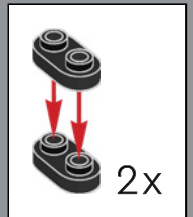



172

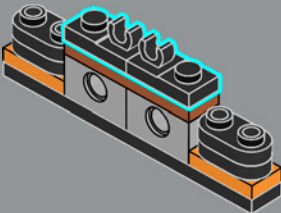

173

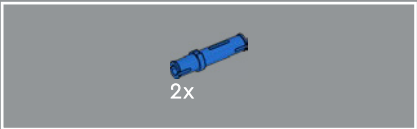
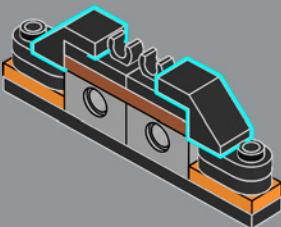

174

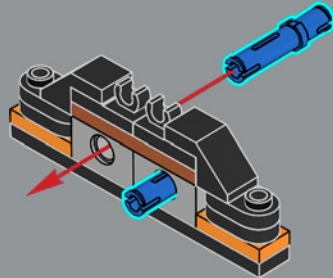



175

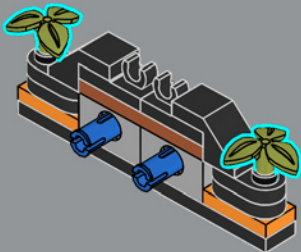

176

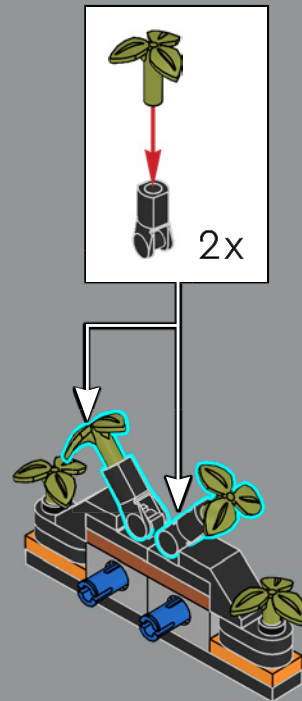

177

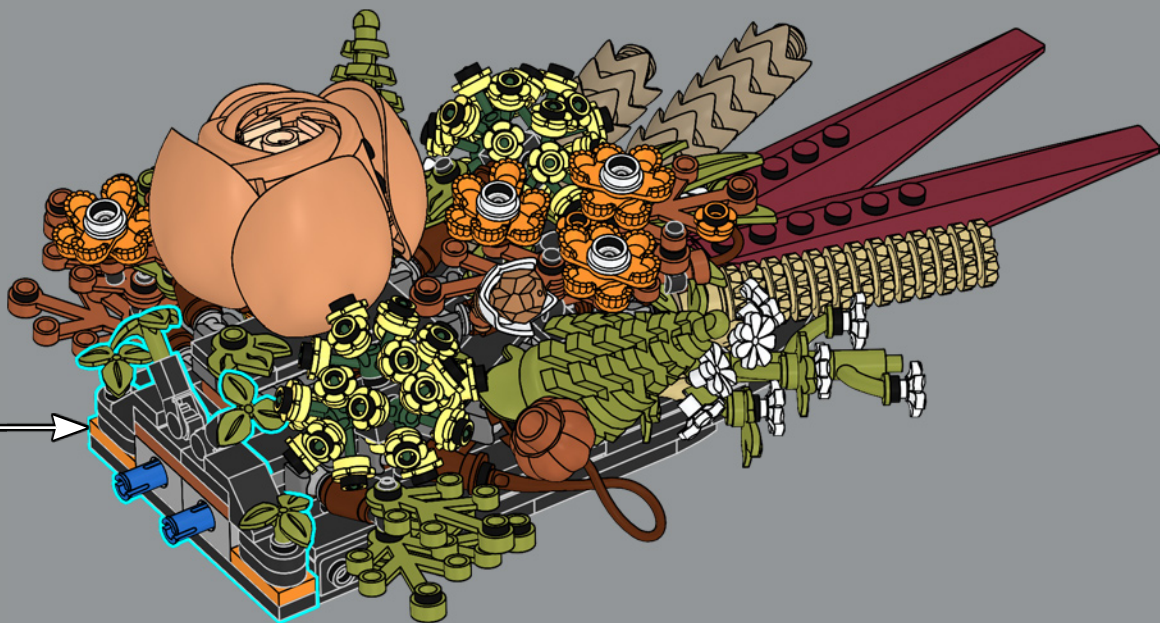





Les fleurs séchées sont parfois conservées à l'aide d'une cire fine. Les éléments brillants de ce set ont été choisis pour reproduire cet aspect cire.

178

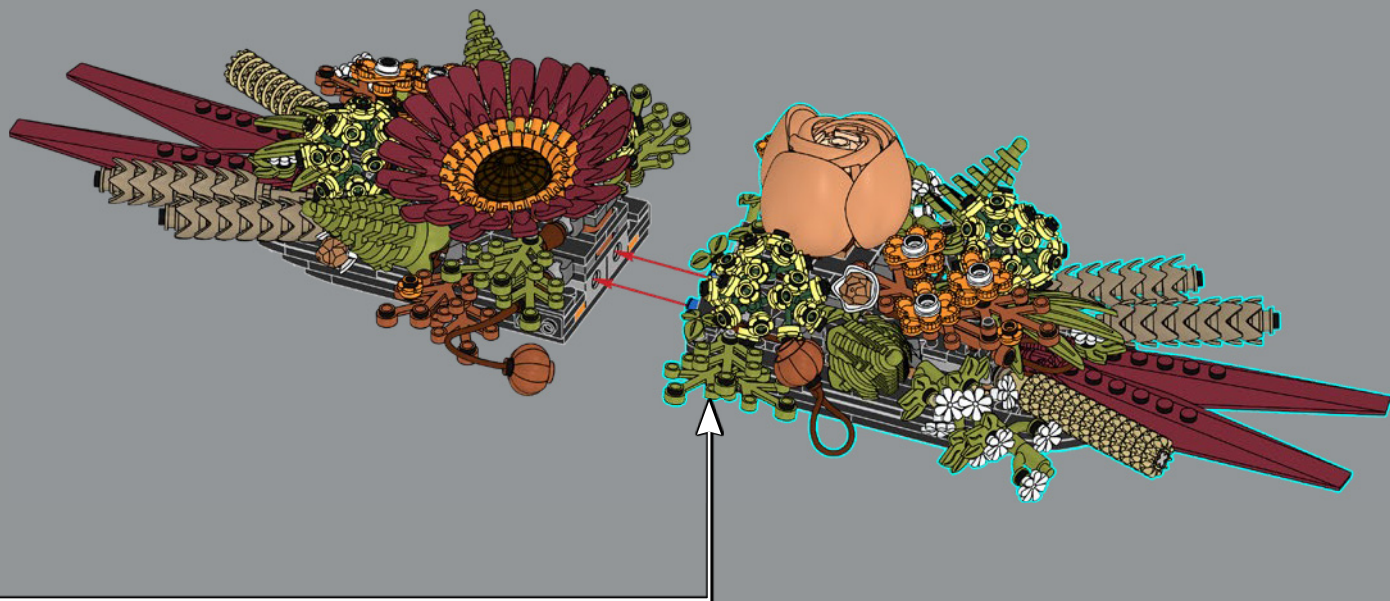

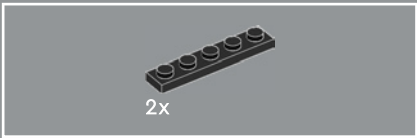

179

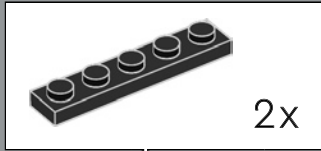

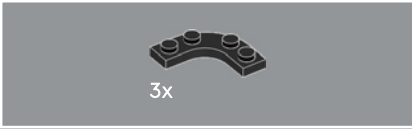
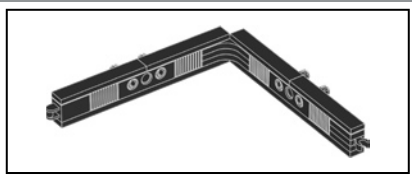

180

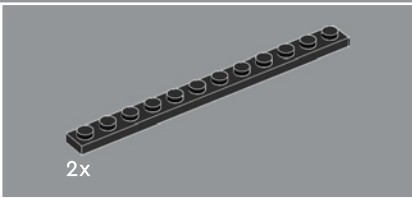
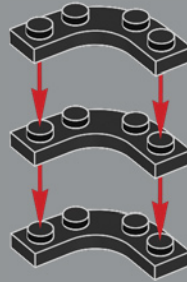

181

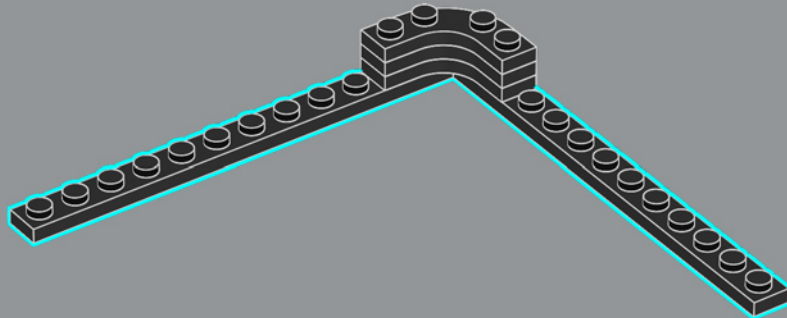

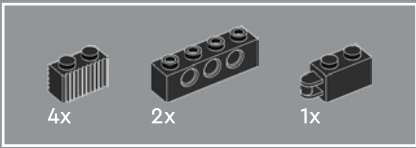

182

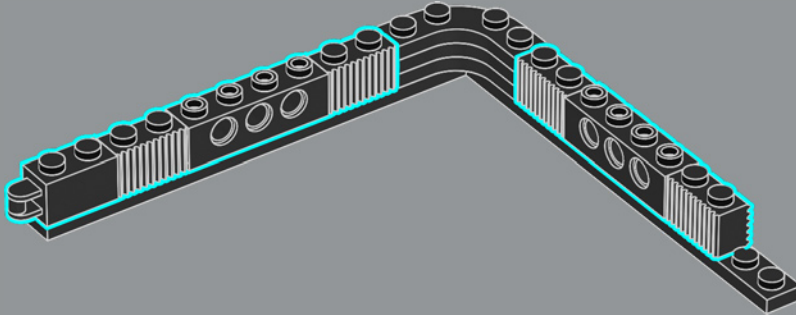

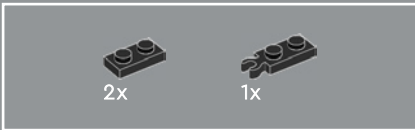

183

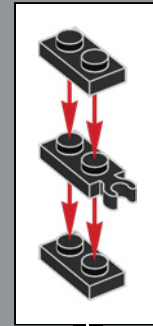
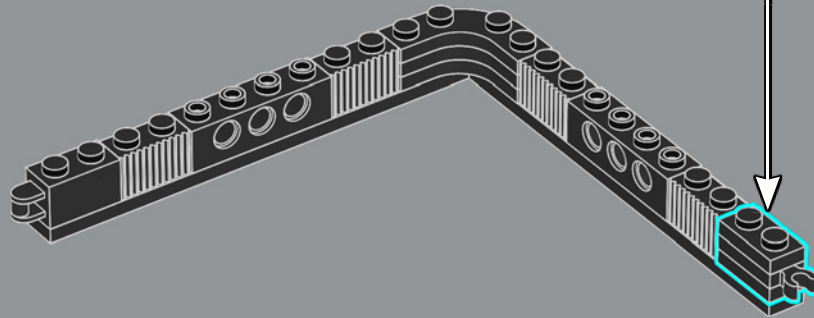

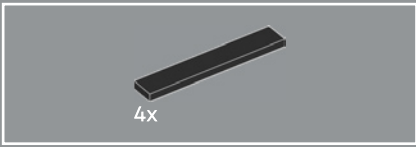

184

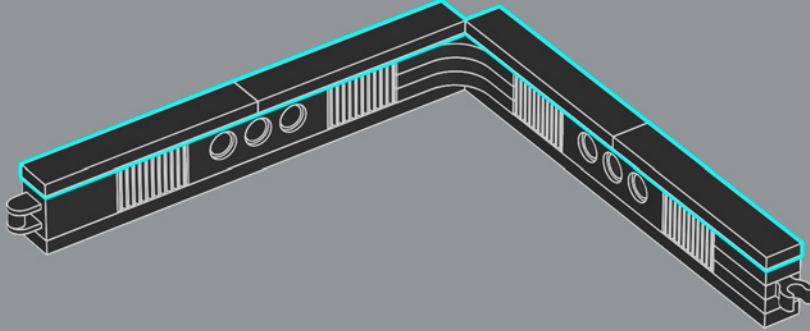

185

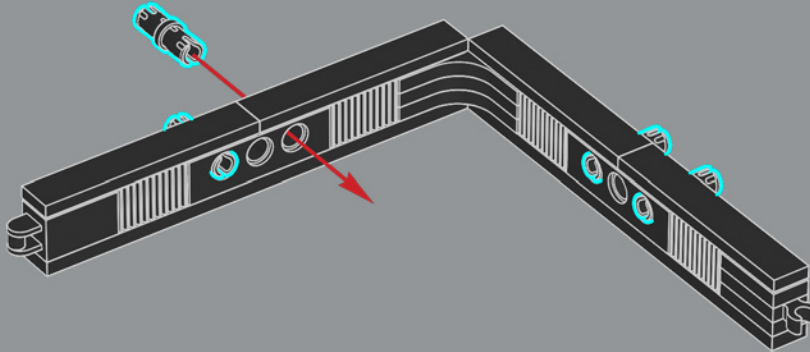

186

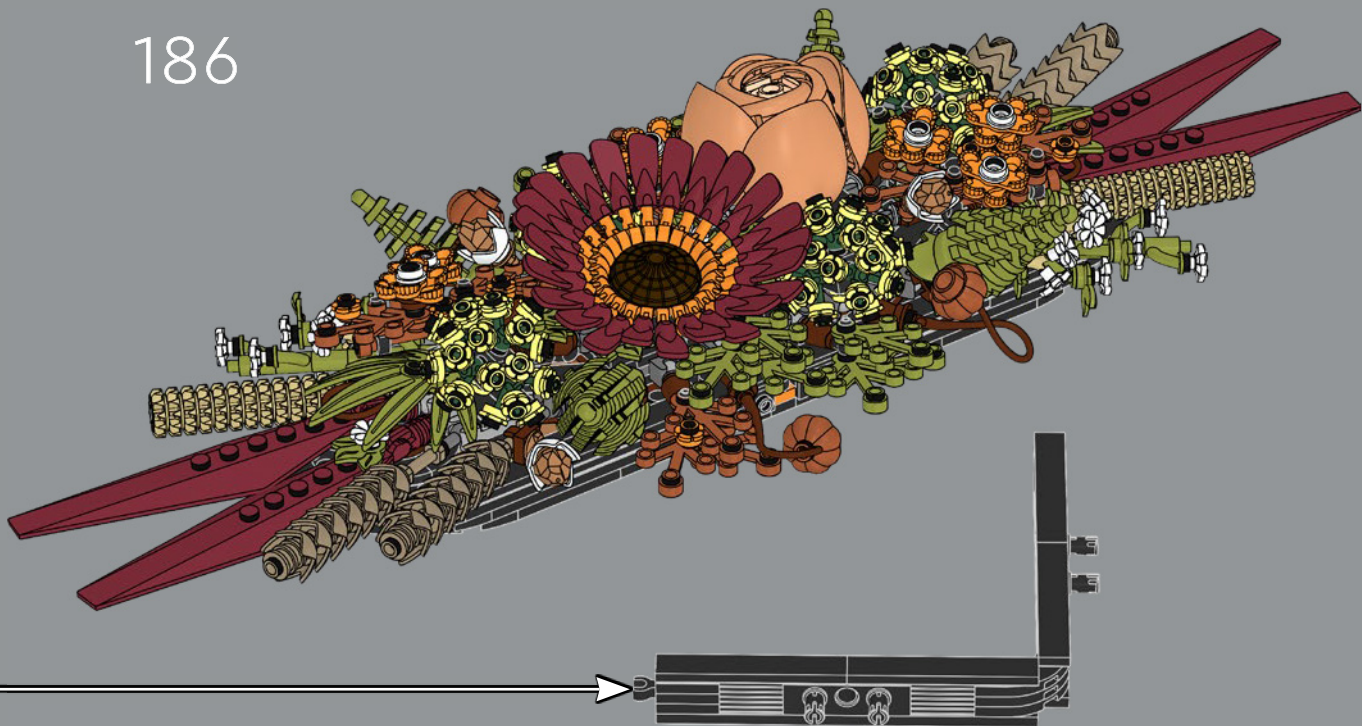







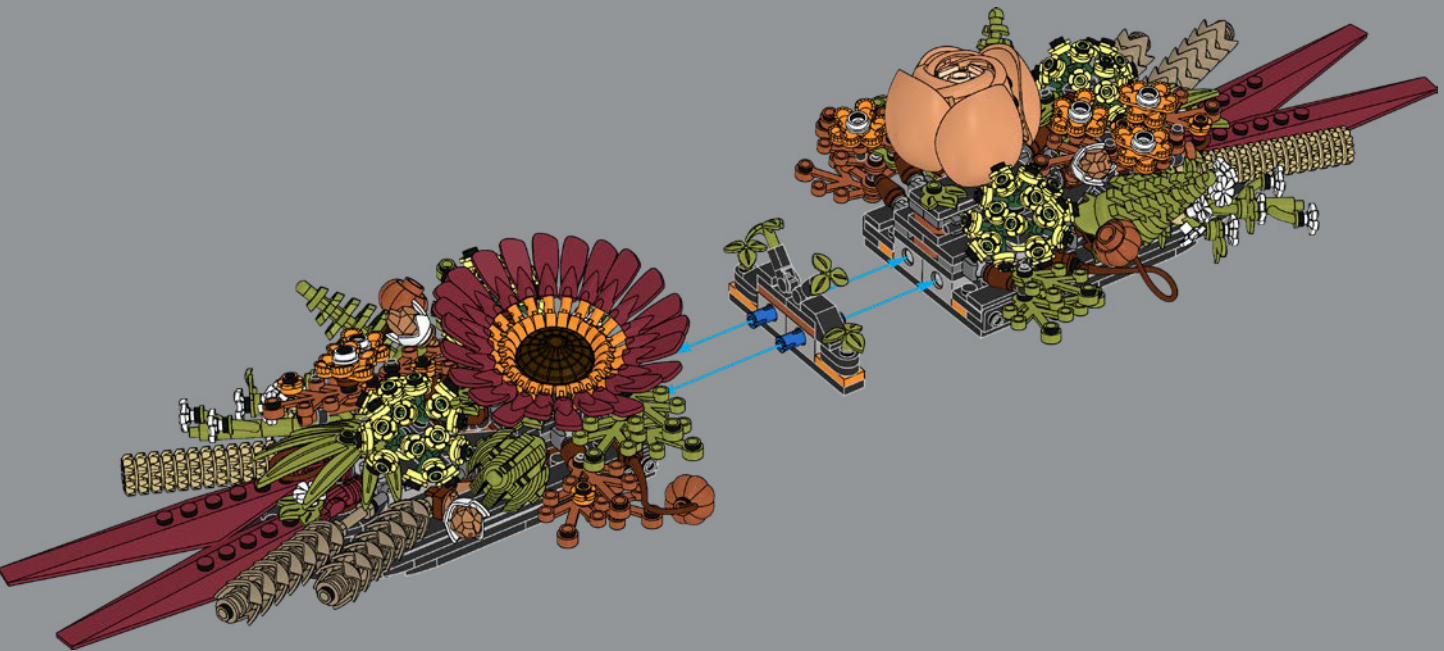

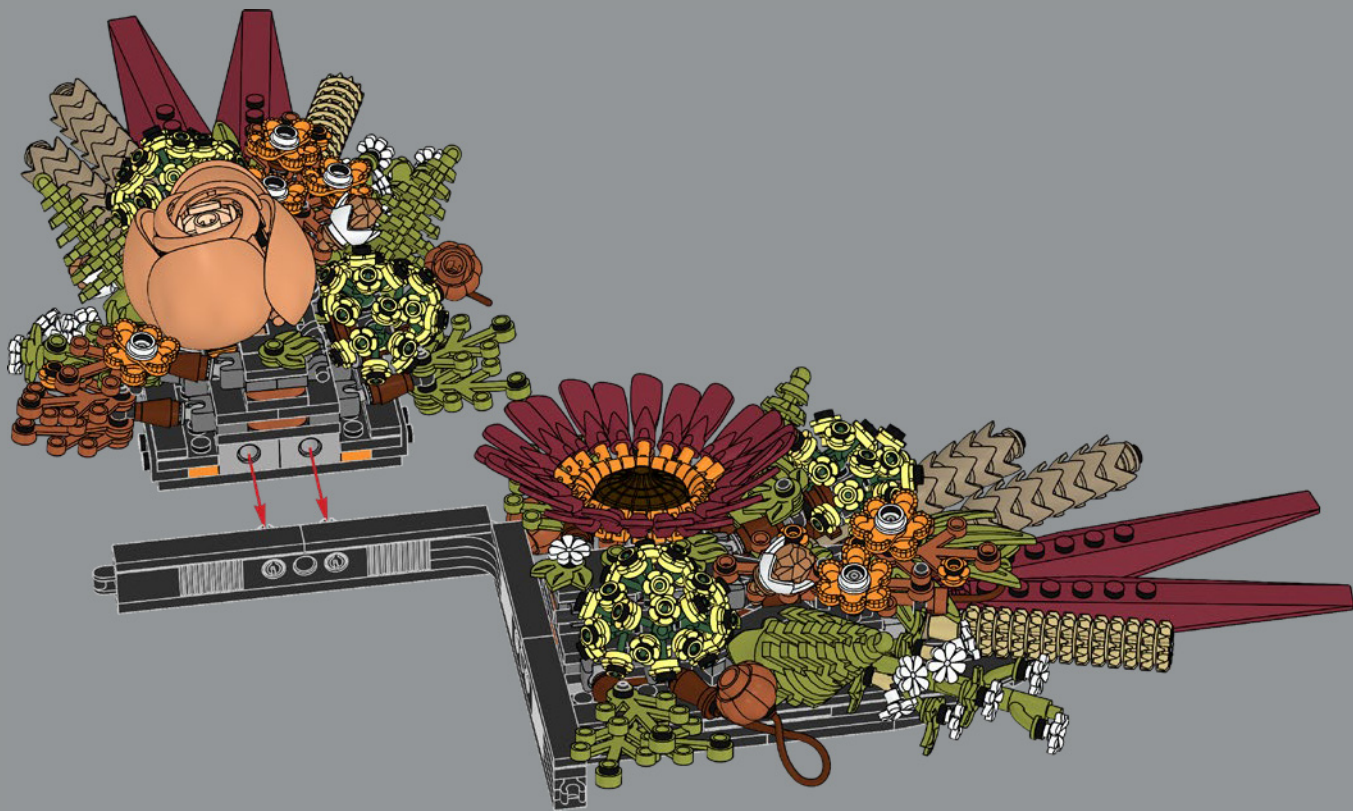



3 x 10314

