



## APPREZZATE DA SECOLI, SEMPRE IN FIORE

Teofrasto, un allievo di Aristotele, le adorava. Confucio, il grande filosofo, ha composto poesie su di esse. Per secoli, le orchidee hanno trovato la loro strada nel cuore di molte persone e oggi la trovano nel tuo. Mentre altre orchidee richiedono alti livelli di attenzione, l'Orchidea LEGO® prospera anche con poca luce, non richiede un'umidità estrema ed è probabilmente molto più facile da far fiorire.





I tre modelli non possono essere costruiti simultaneamente.

## **I FIORI, COME PIACCIONO A TE.**

Con sei fiori standard e due boccioli più piccoli, è possibile regolare la lunghezza degli steli, ruotare le radici e le foglie e creare nuove composizioni semplicemente posizionando i fiori come vuoi tu.





## IL DESIGN TEAM

Mike progetta prodotti LEGO® da oltre 9 anni. Creare la geometria del vaso è stata una delle sue sfide preferite in questo modello. *"Progettare orchidee in un vaso scanalato blu sabbia, che non sono solo divertenti da costruire ma anche belli da guardare, è stata una sfida avvincente per me. Mi sono ispirato alle vere orchidee, ovviamente, ma devo dire che prendersi cura dell'Orchidea LEGO è molto più facile ed è certamente molto più divertente da avere in casa".*

**Michael Psiaki, Design Master**



# COLTIVA LA TUA COLLEZIONE CON I MODELLI LEGO® BOTANICAL



**10280**  
Bouquet di fiori



**10289**  
Uccello del paradiso



**10281**  
Albero Bonsai



**10309**  
Piante grasse

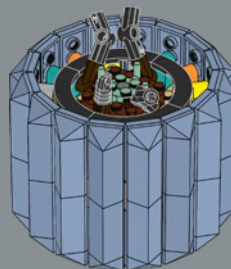
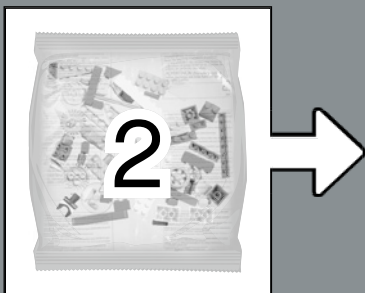
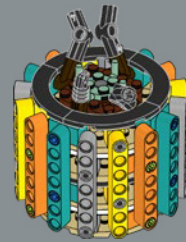
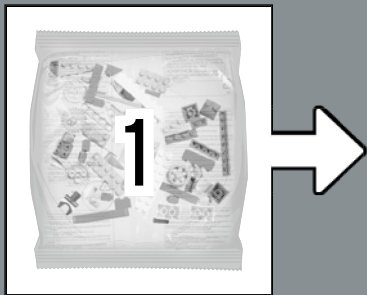
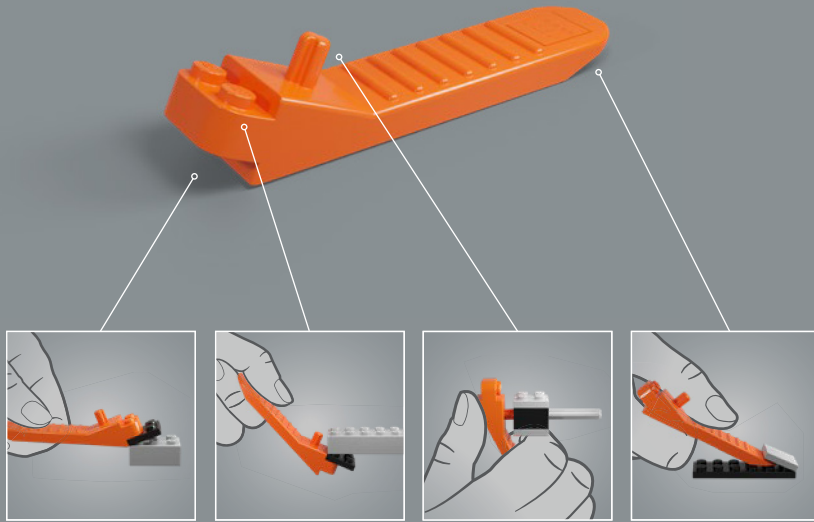

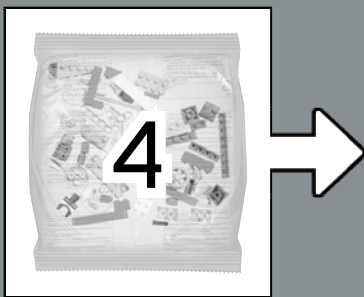
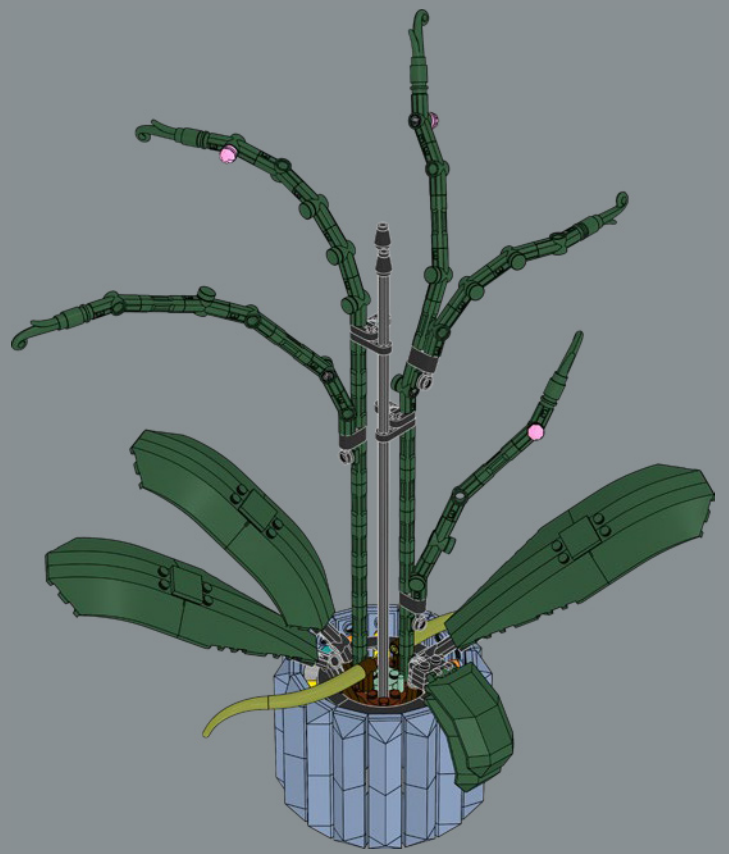
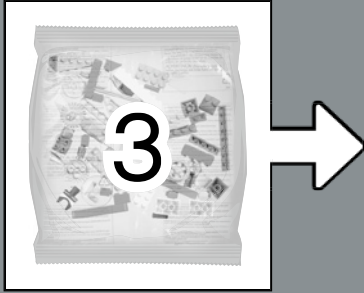



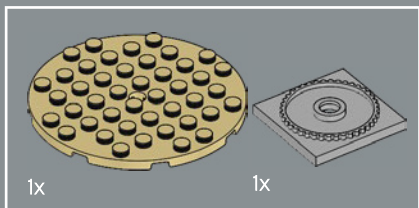

1

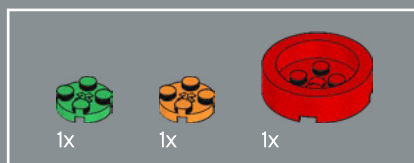
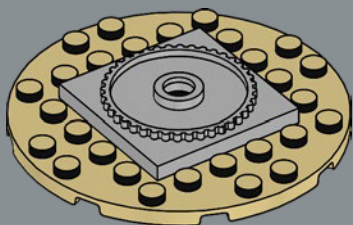

2

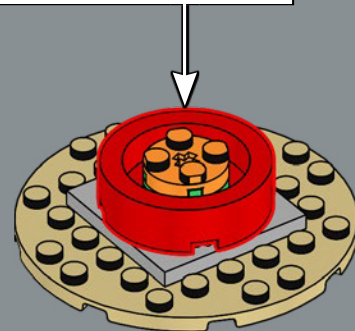
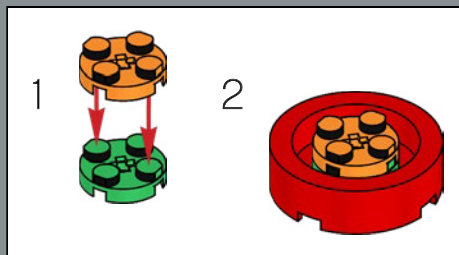



3

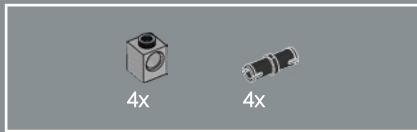
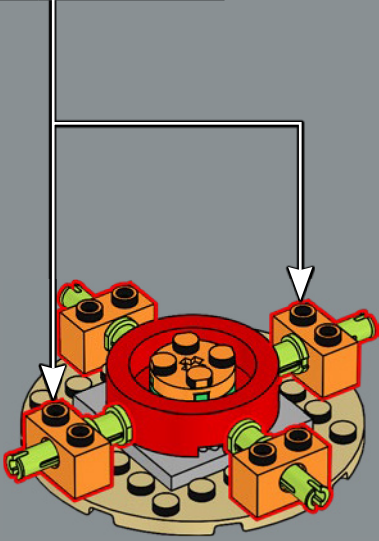
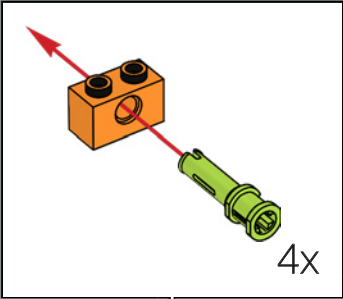

4

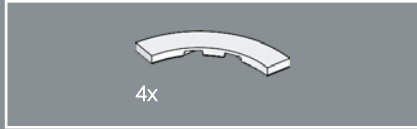
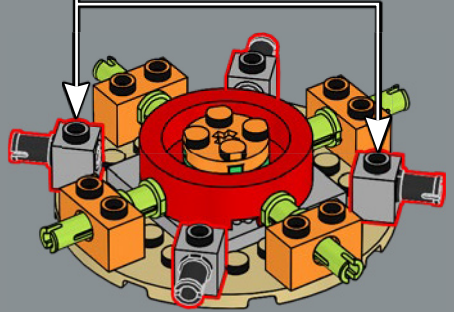
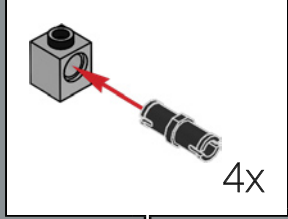

5







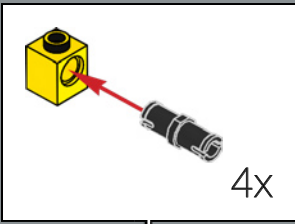

4

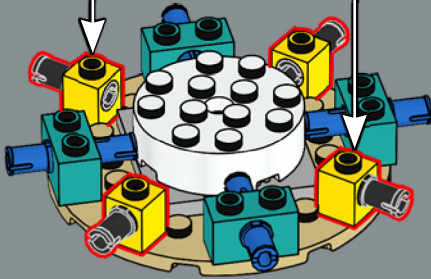

5

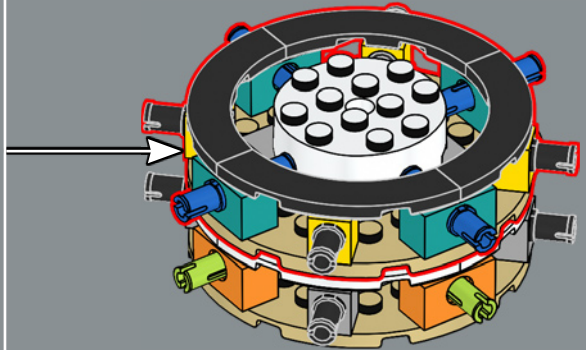
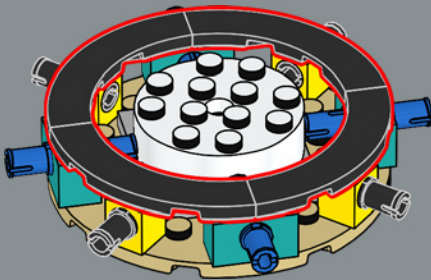

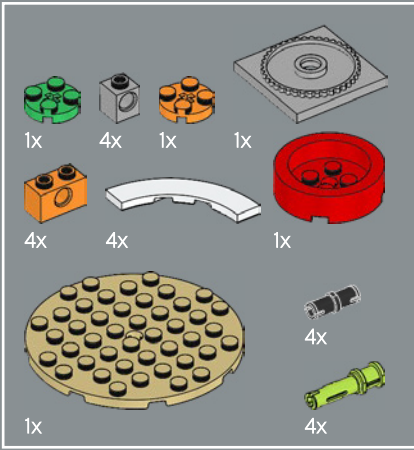
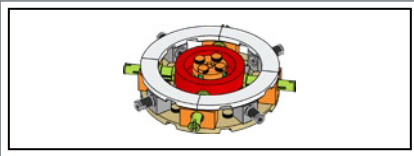

7

1

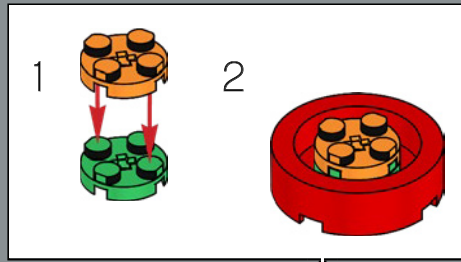
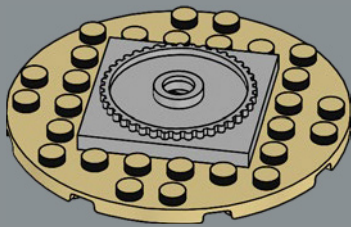

2

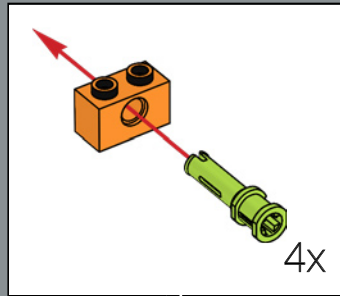
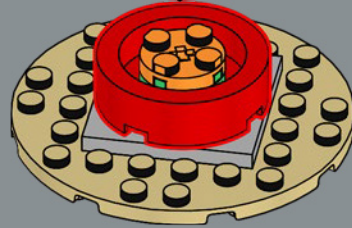

3

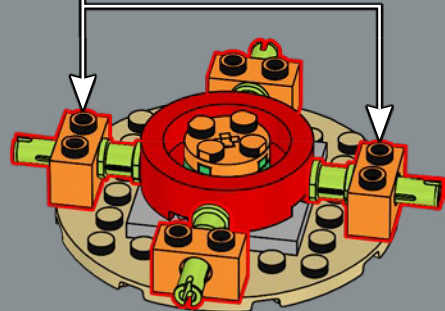



Il nucleo del vaso è una versione modificata del nucleo usato nella grande torre del set Castello di LEGO® Hogwarts™ — la professoressa Spruce ne sarebbe entusiasta.

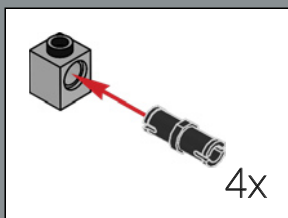

4

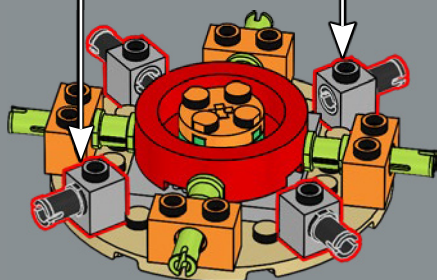

5

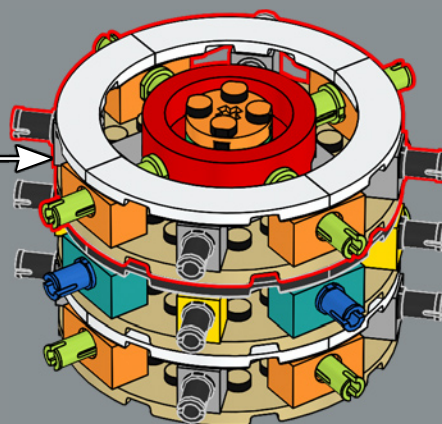
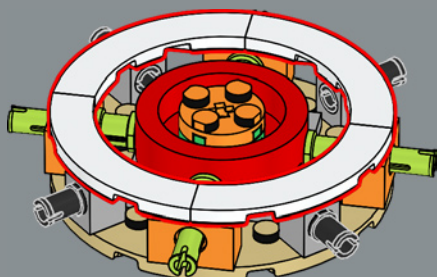



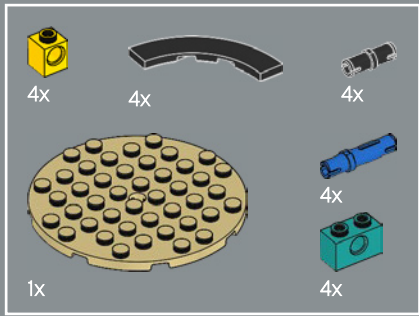

8

1

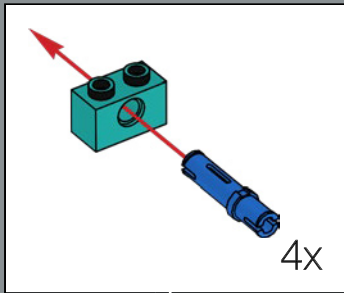
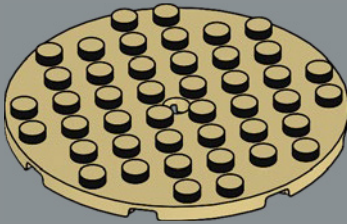

2

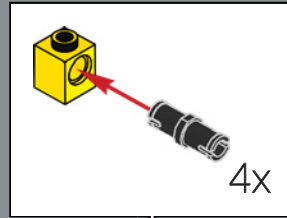
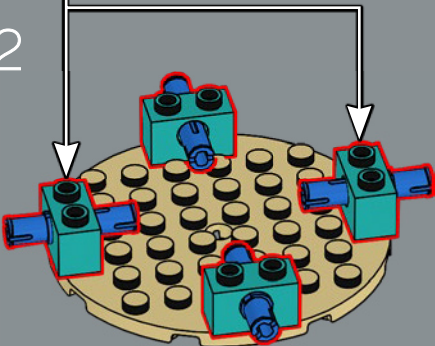

3

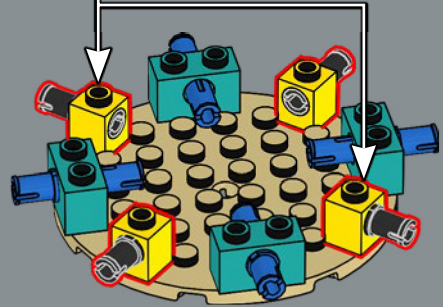

4

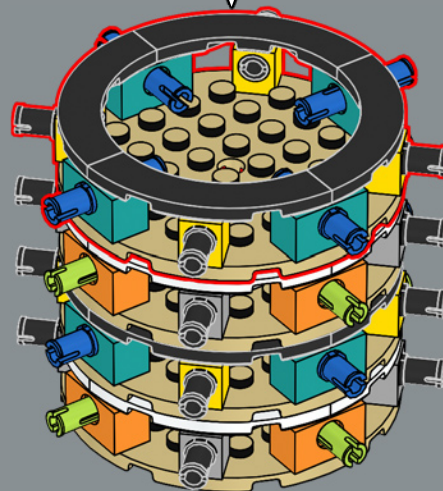
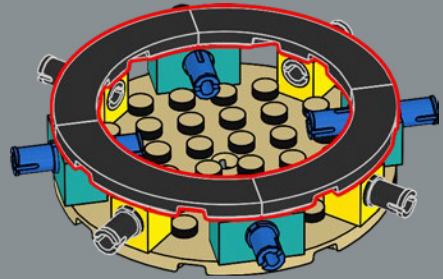

9

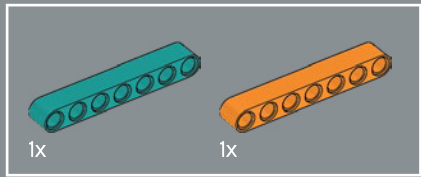
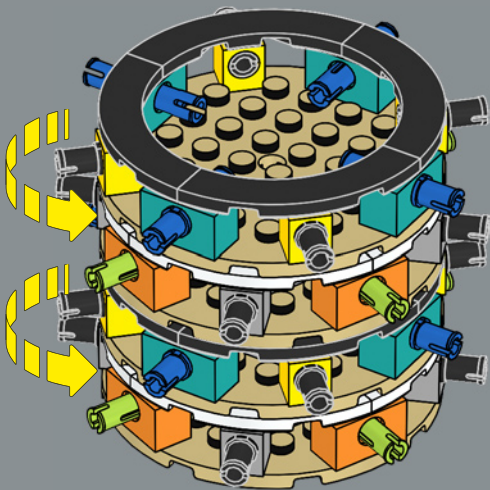

10

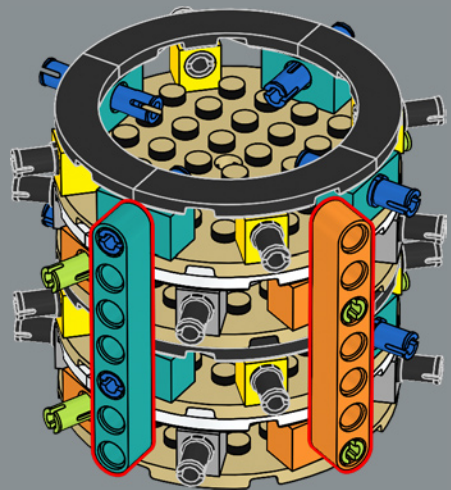

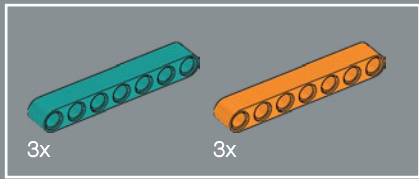

11

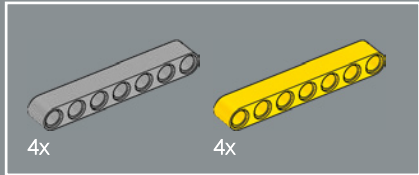
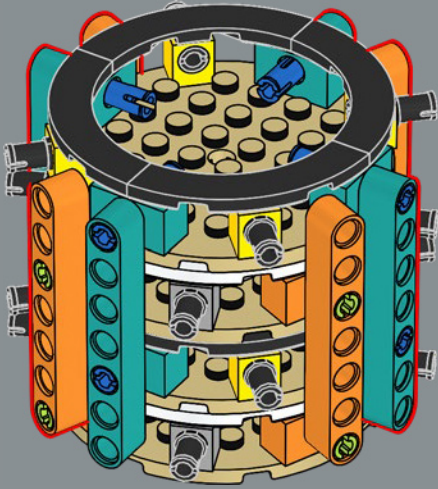

12

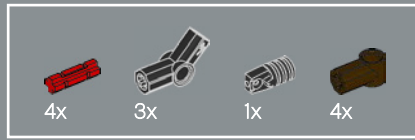
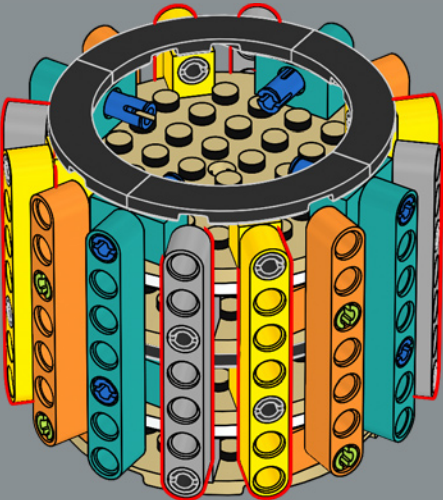

13

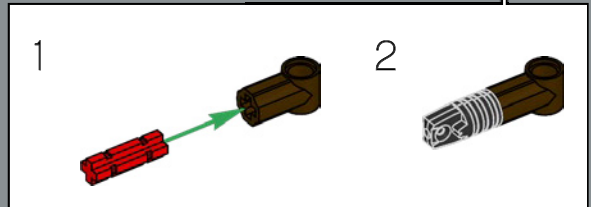
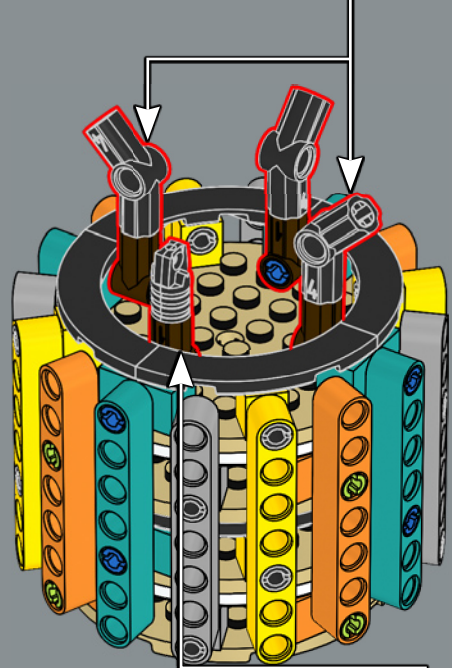
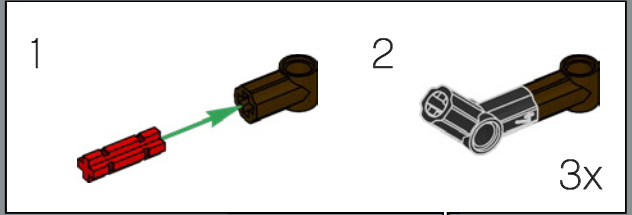





14

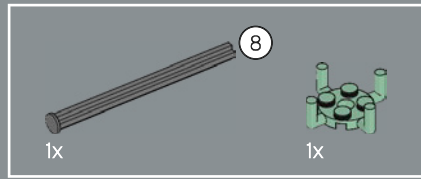
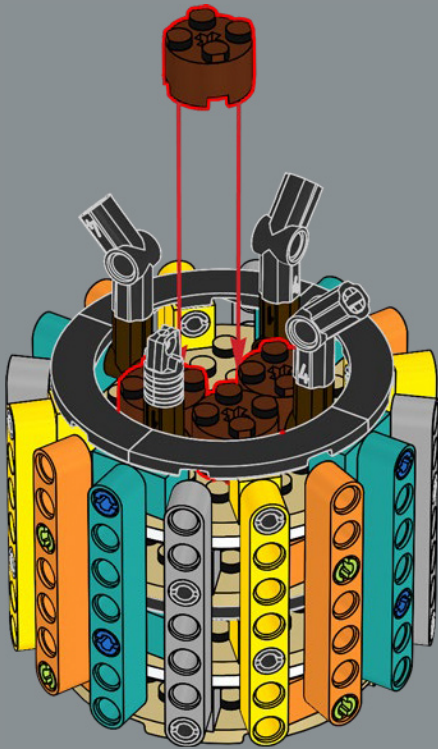

15

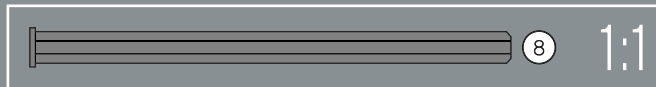
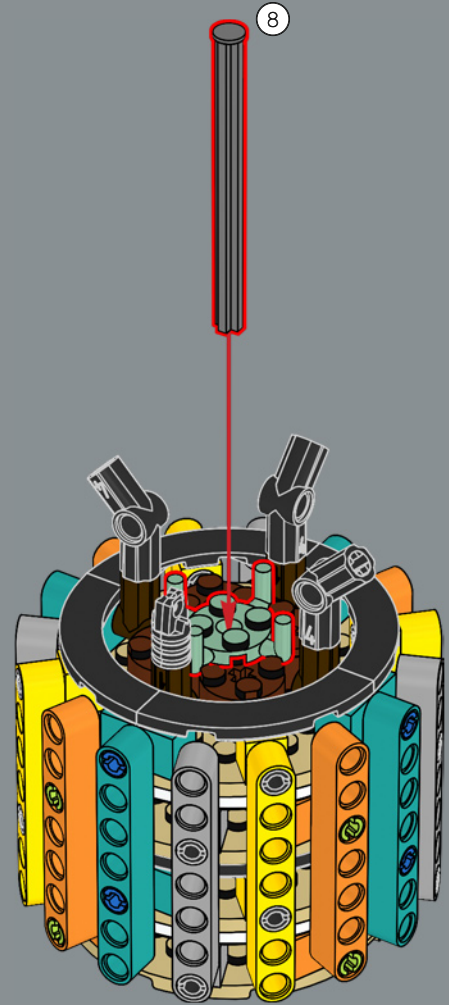



16

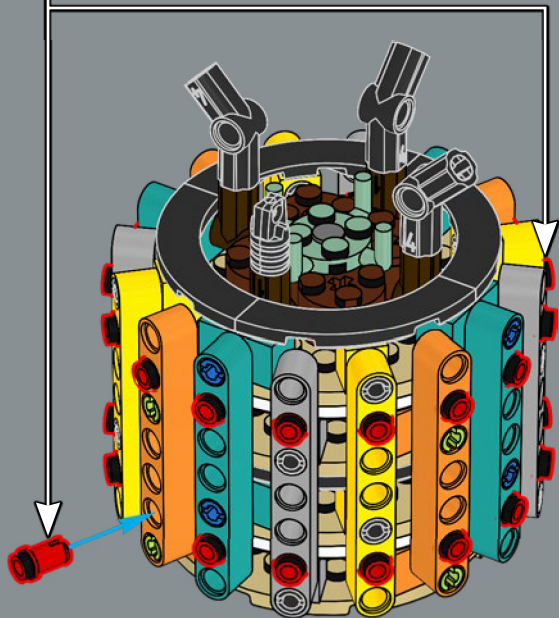

18

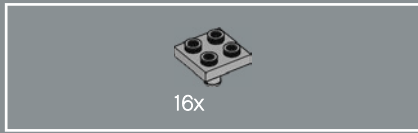

17

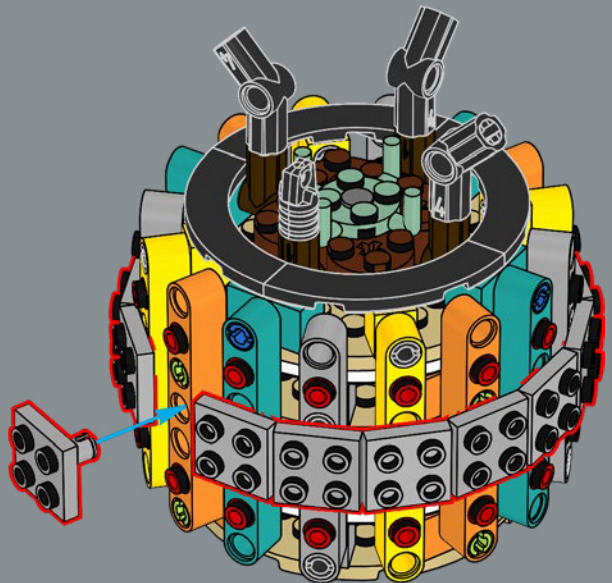

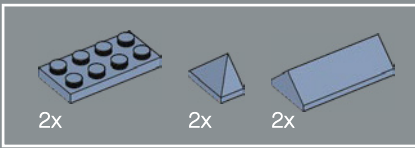

18

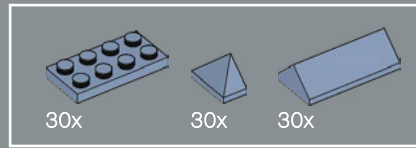
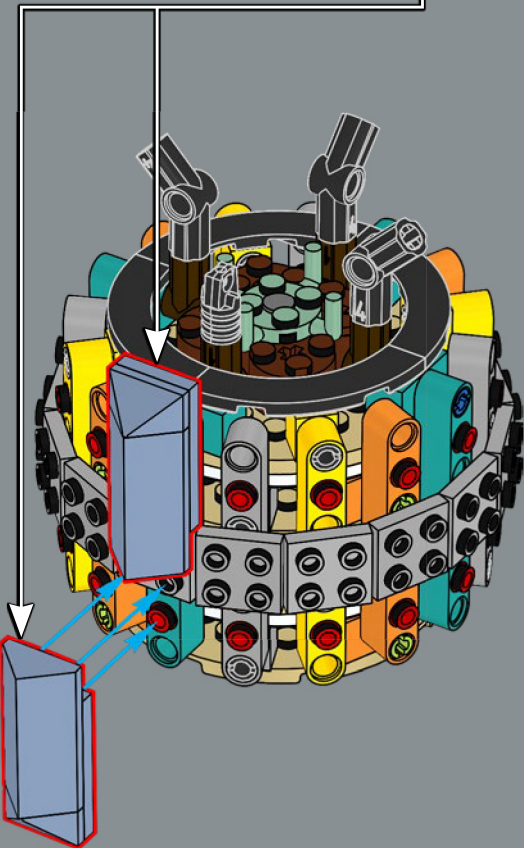
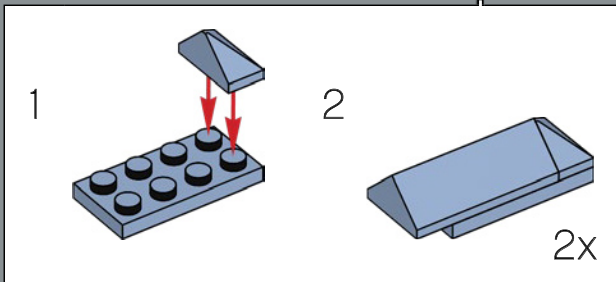

19

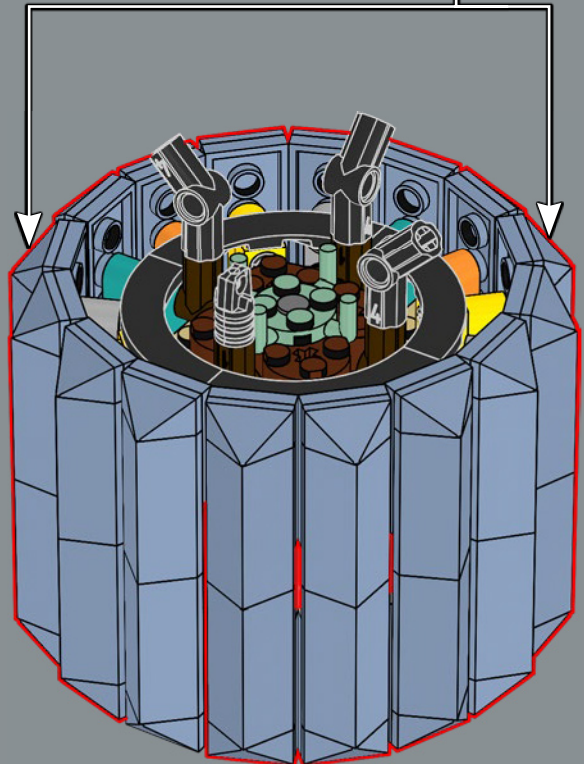
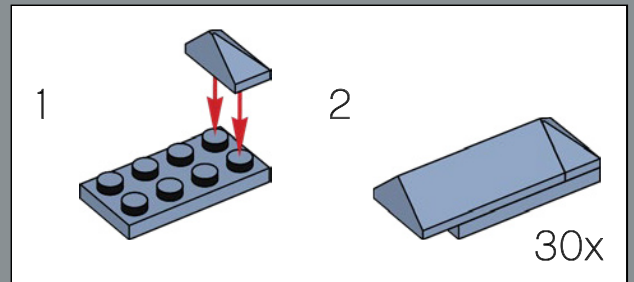

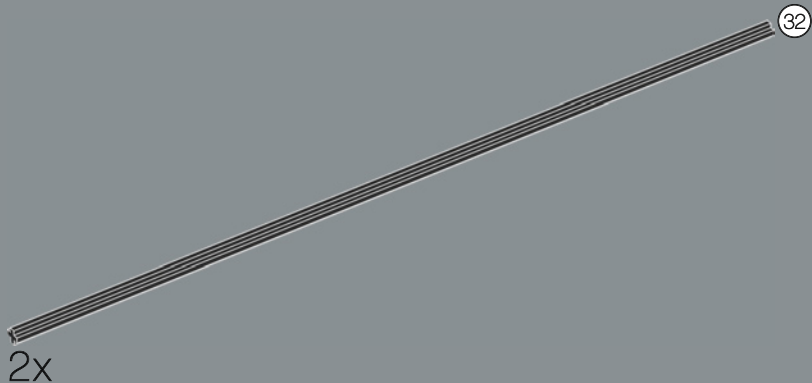
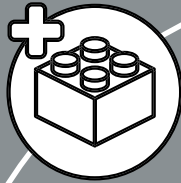





20

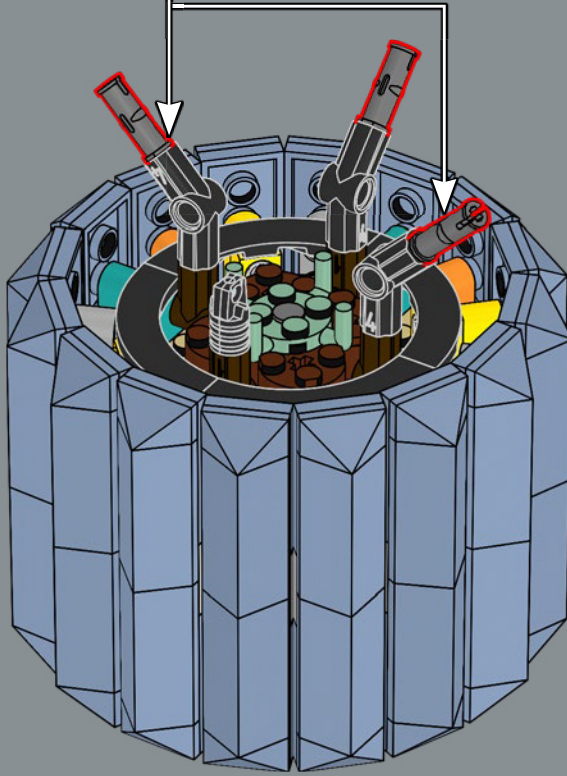
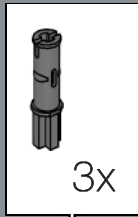

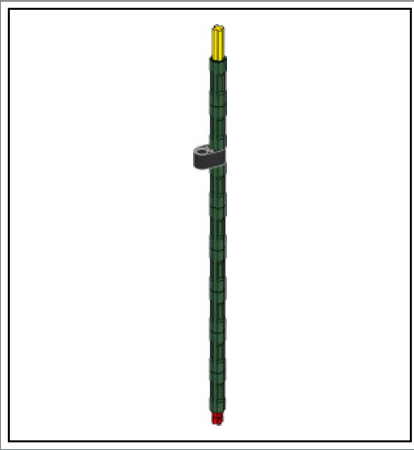

21



22

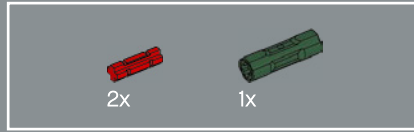
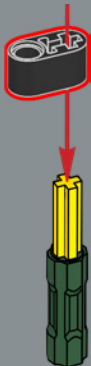

23

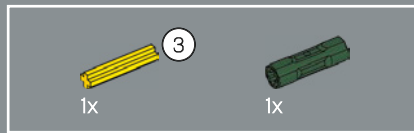
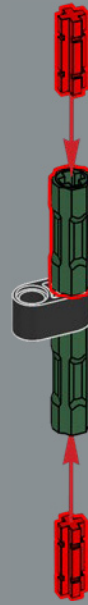

24

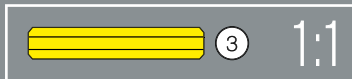

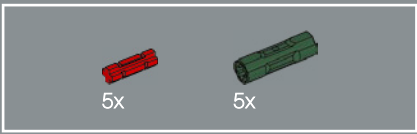

25

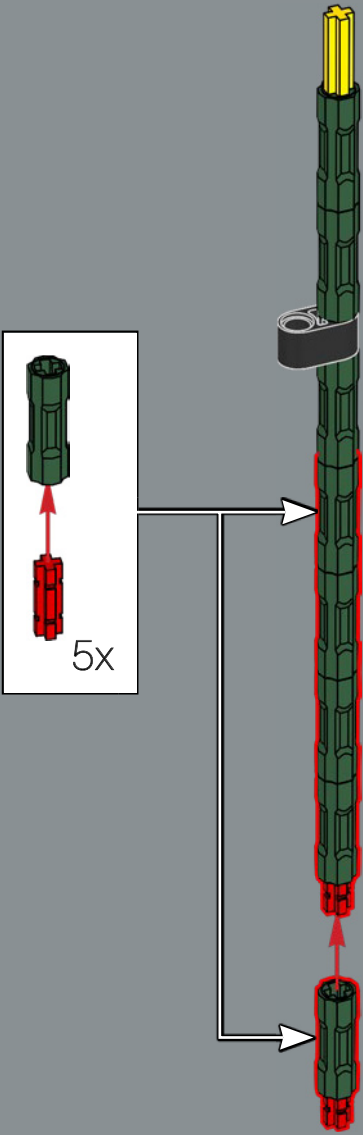

26

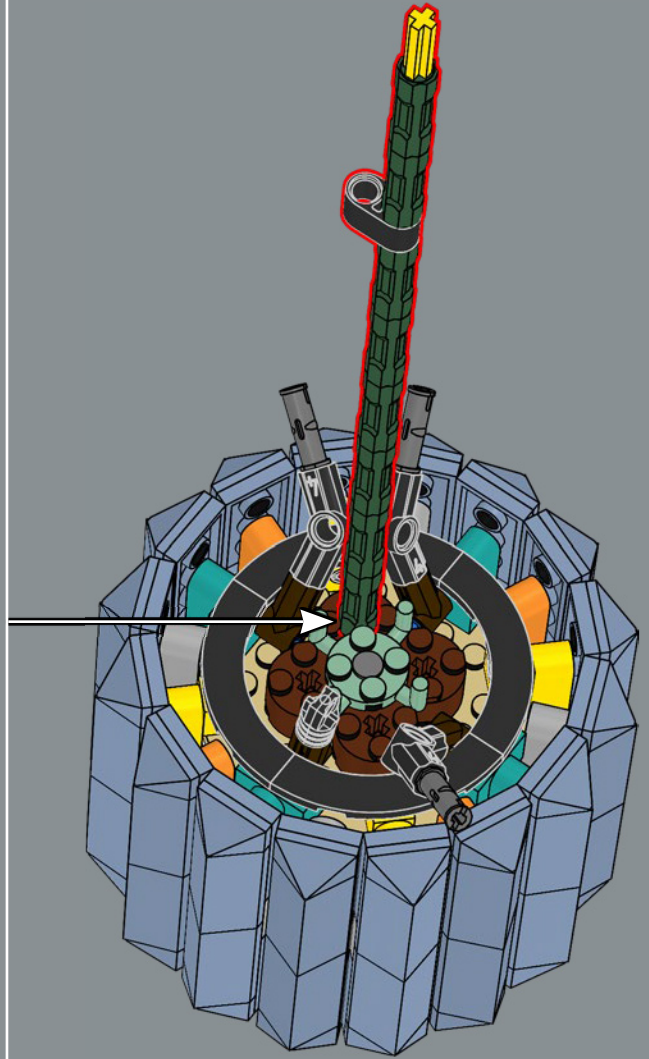

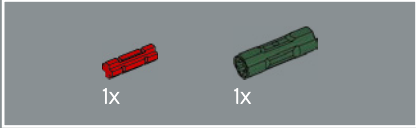
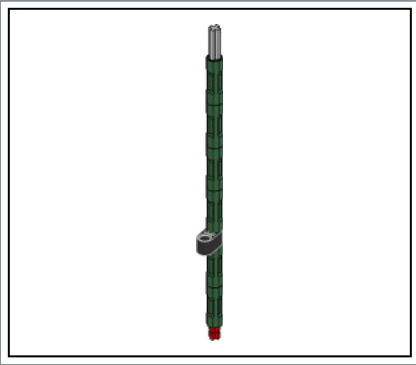

27

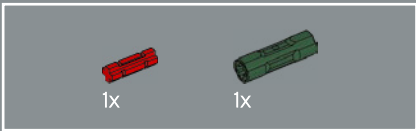

28

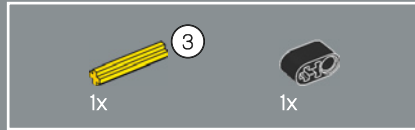

29

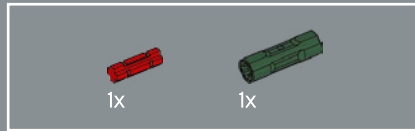
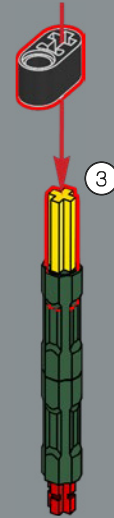

30

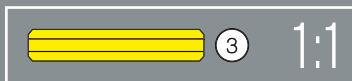



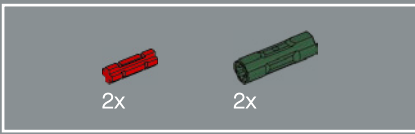

31

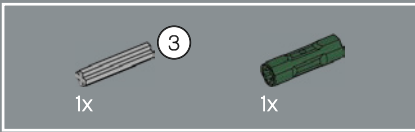
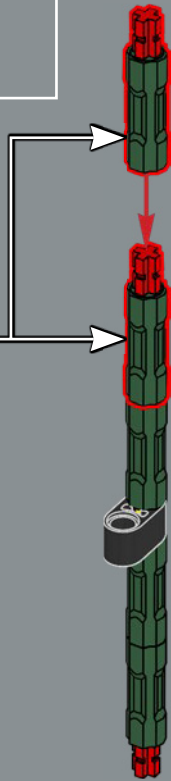
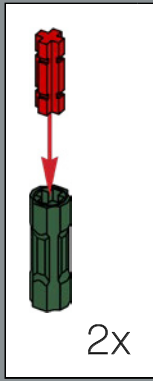

32

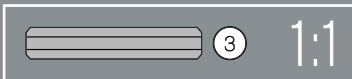

33

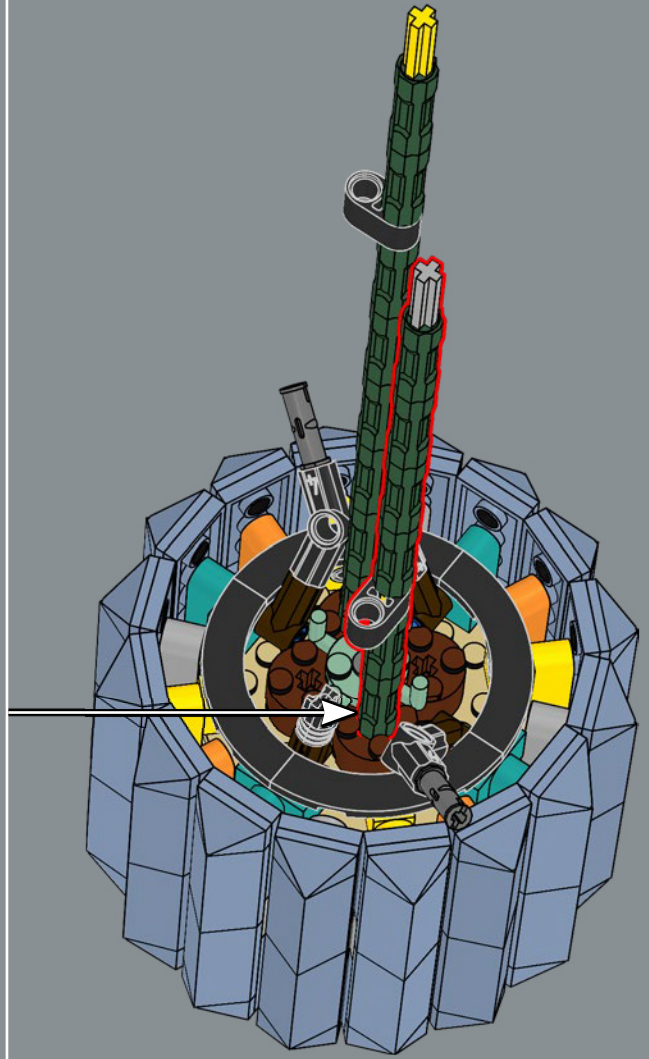

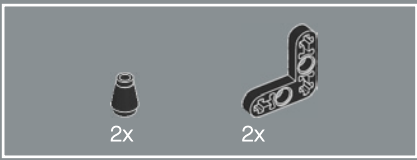

34

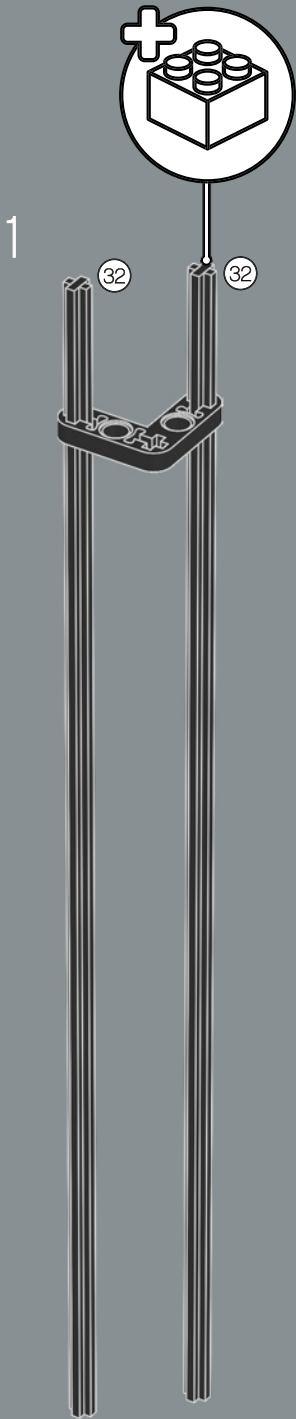

35

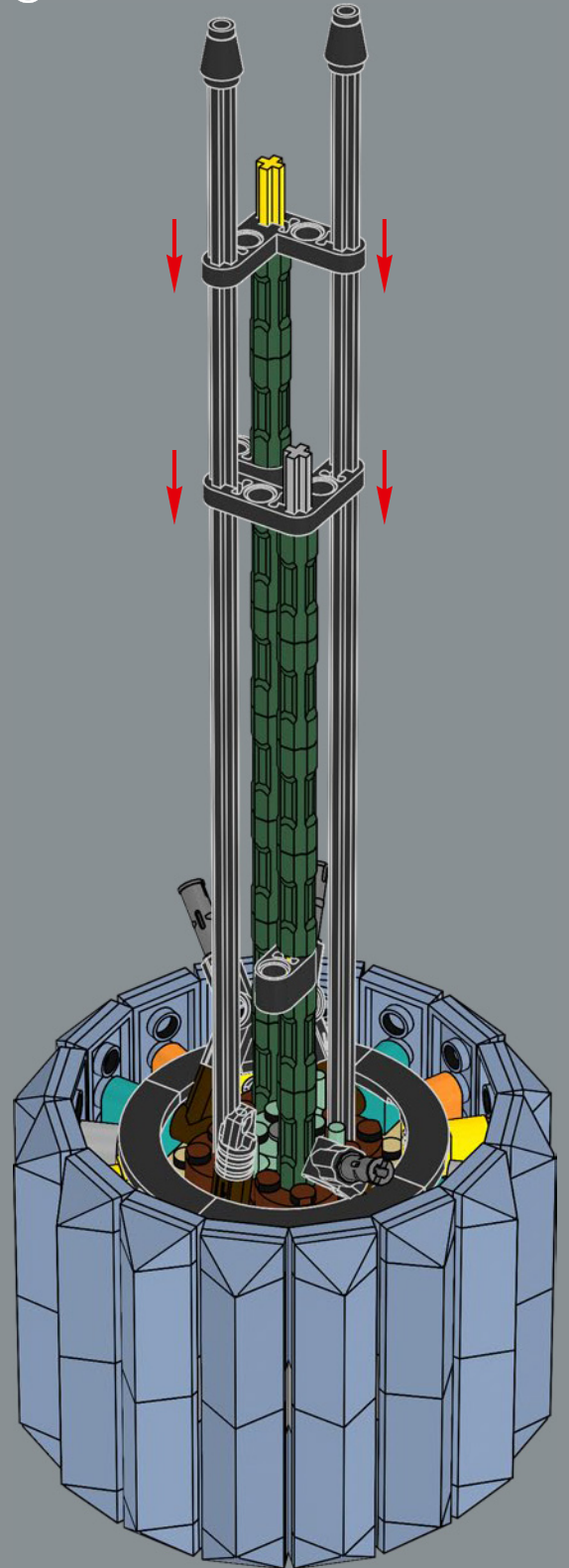
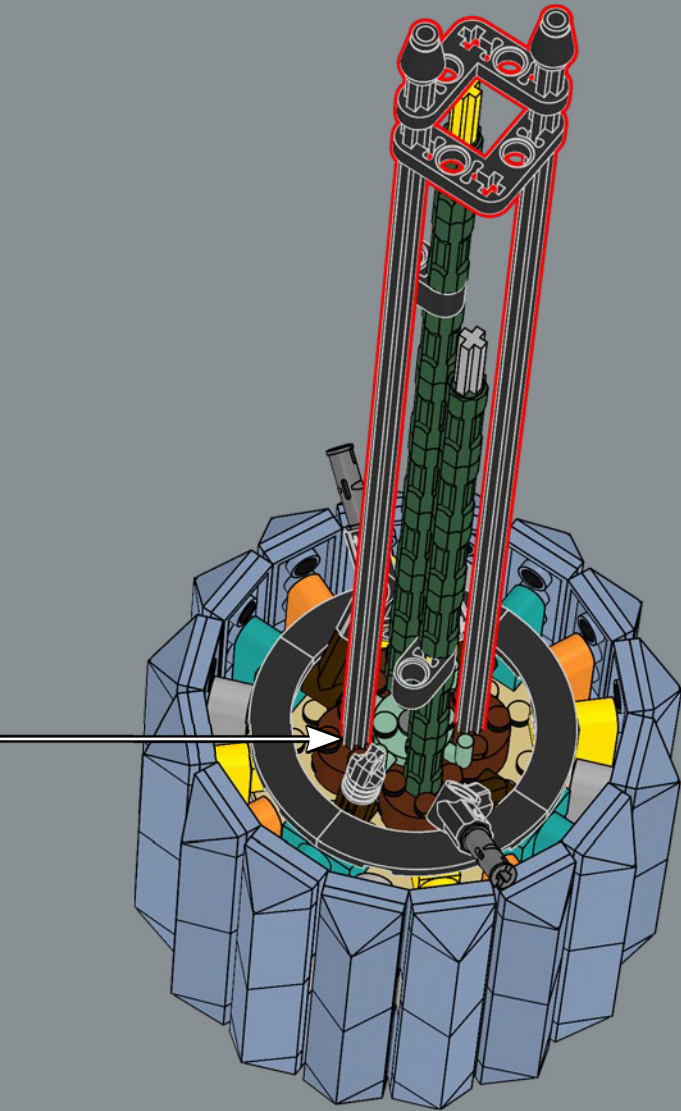



36

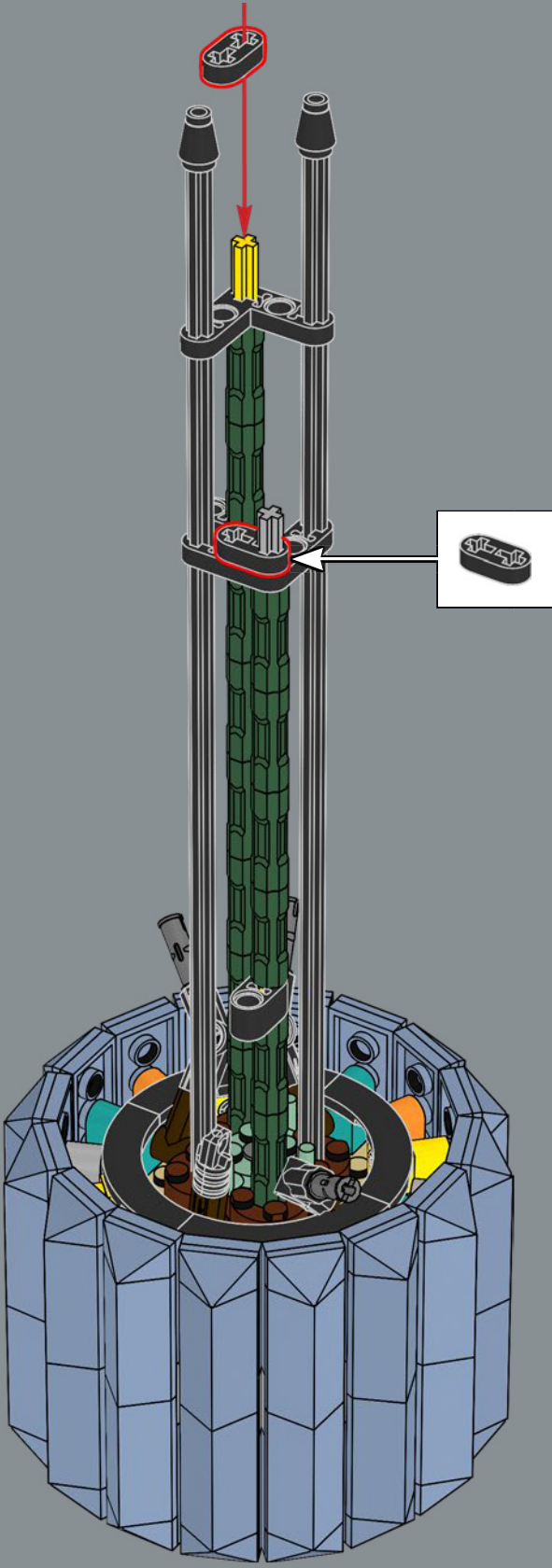



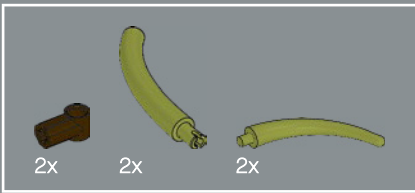

37

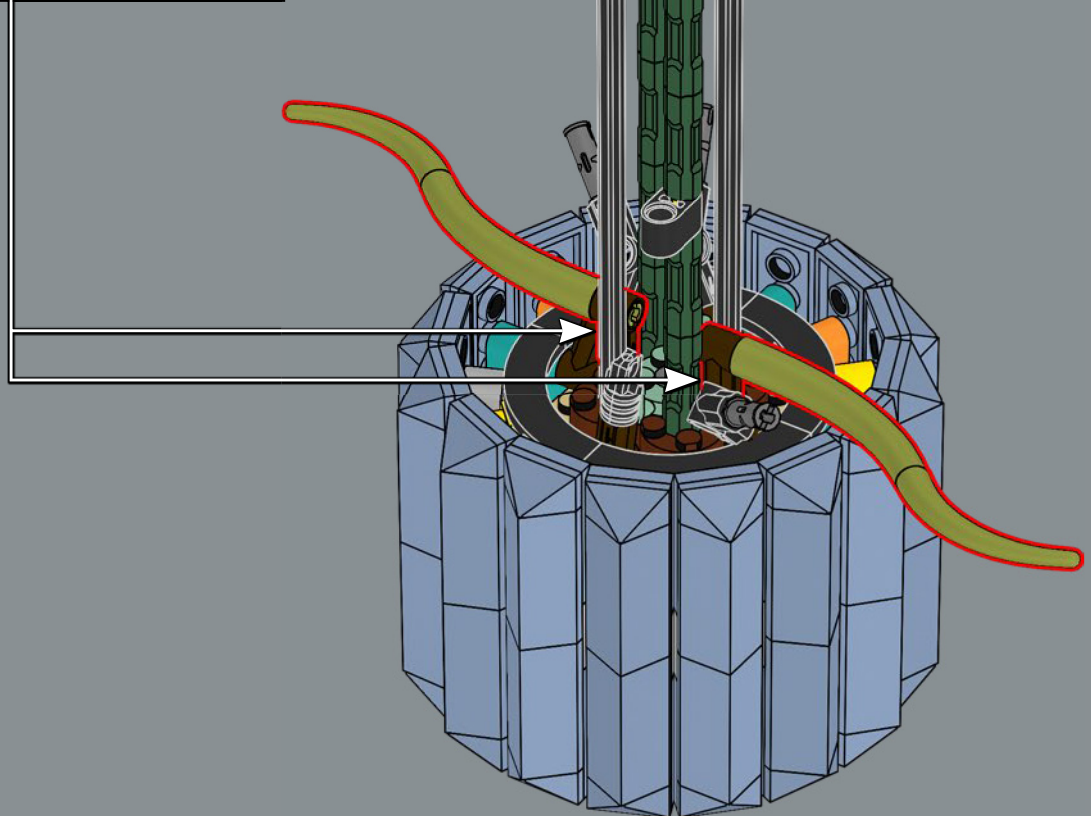
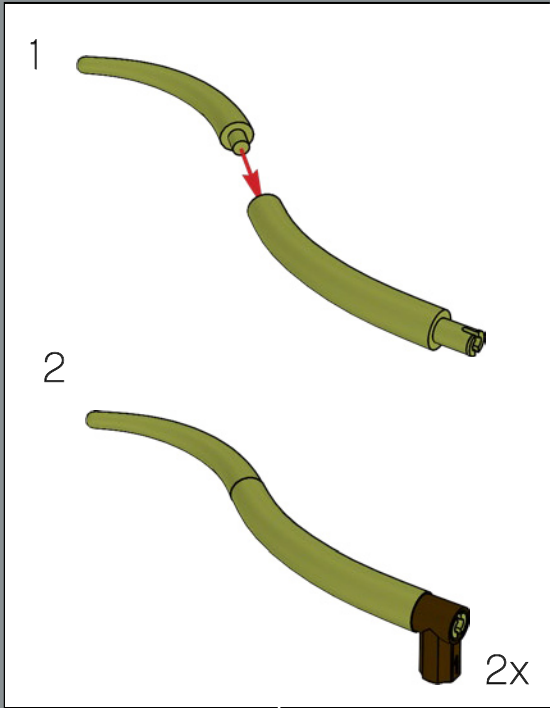

Le radici aeree dell'orchidea sono state realizzate con gli elementi usati per la coda dei dinosauri — ROARRR!

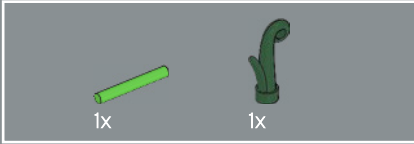
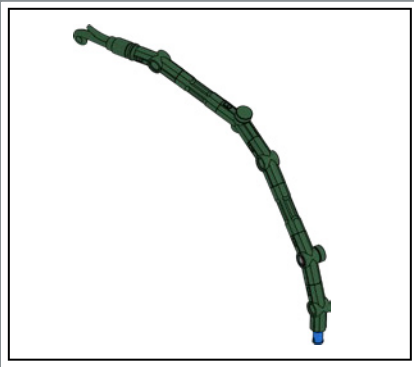

38

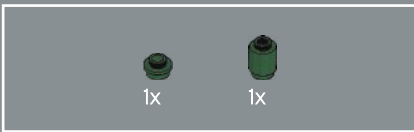
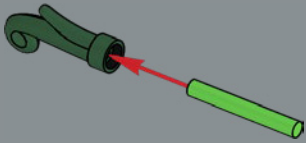

39

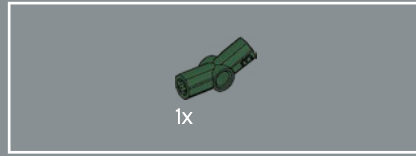
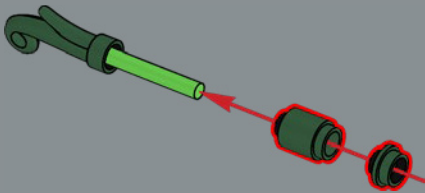

40

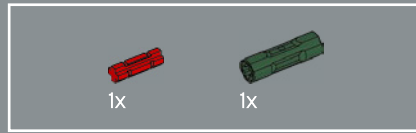
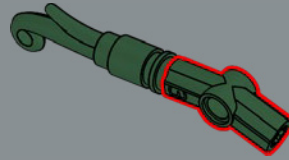

41

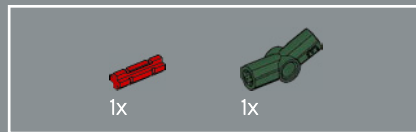
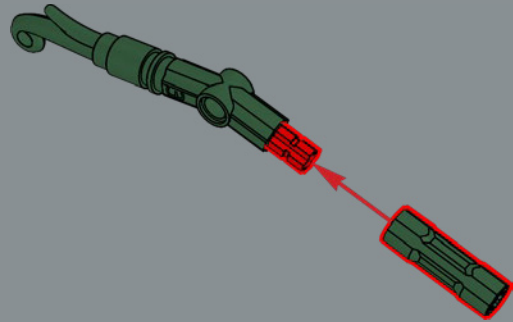

42

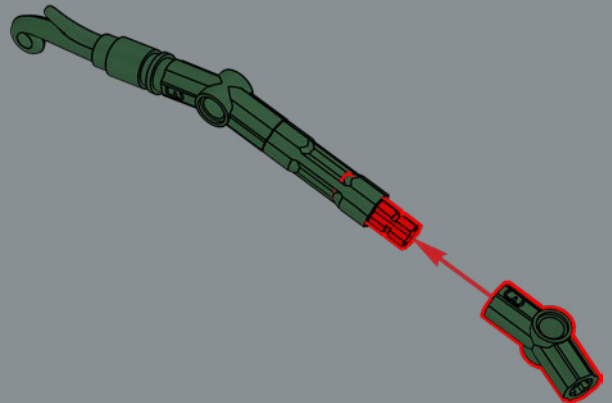

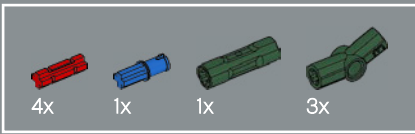

43

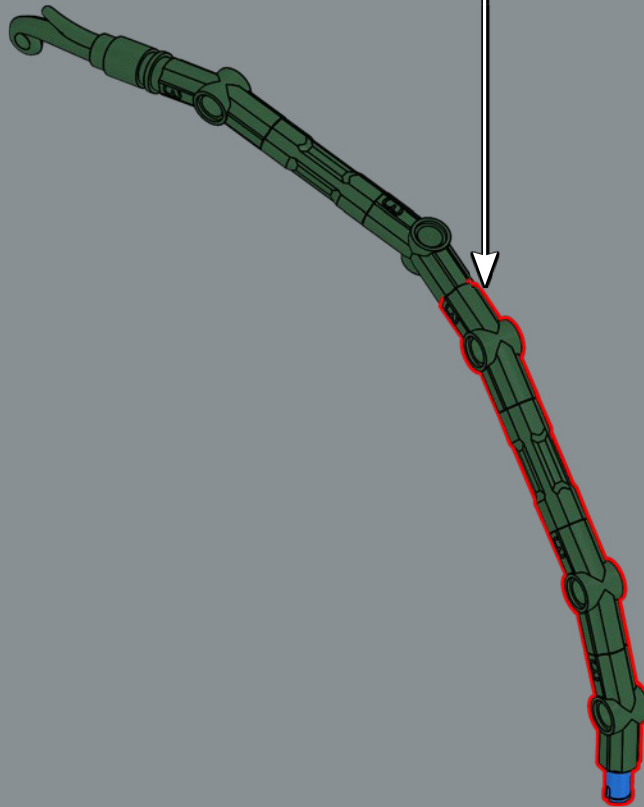
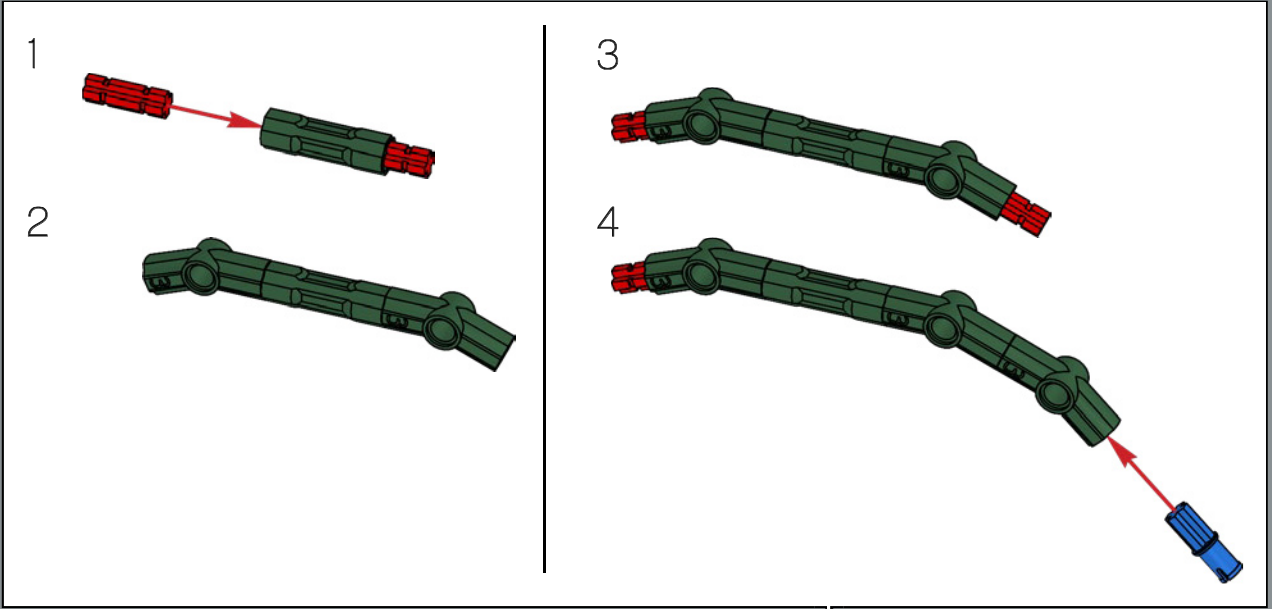

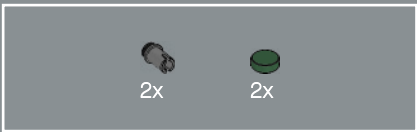

44

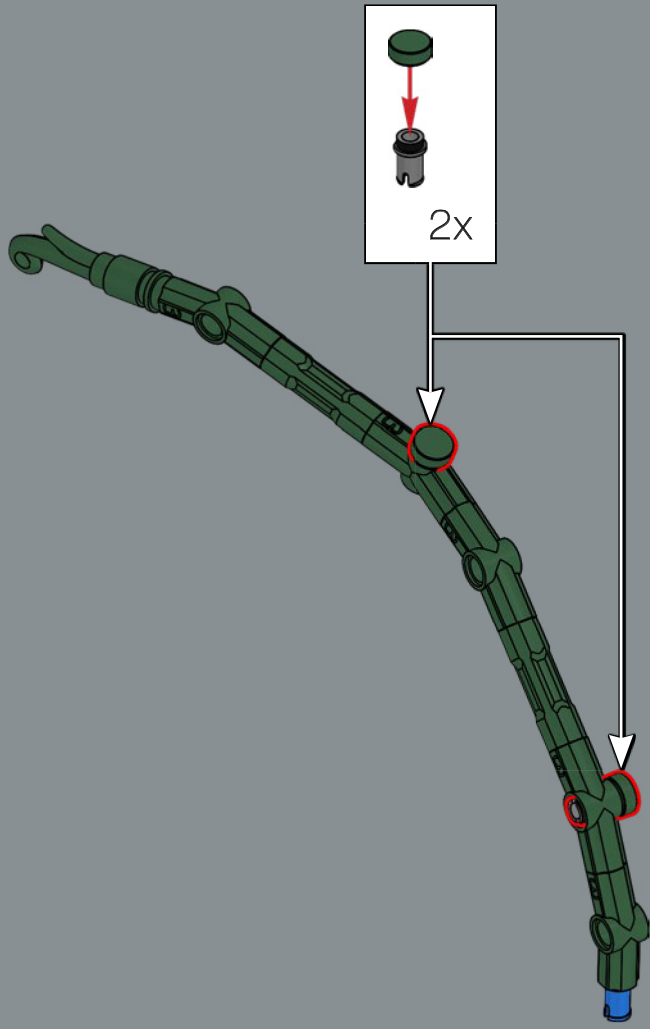



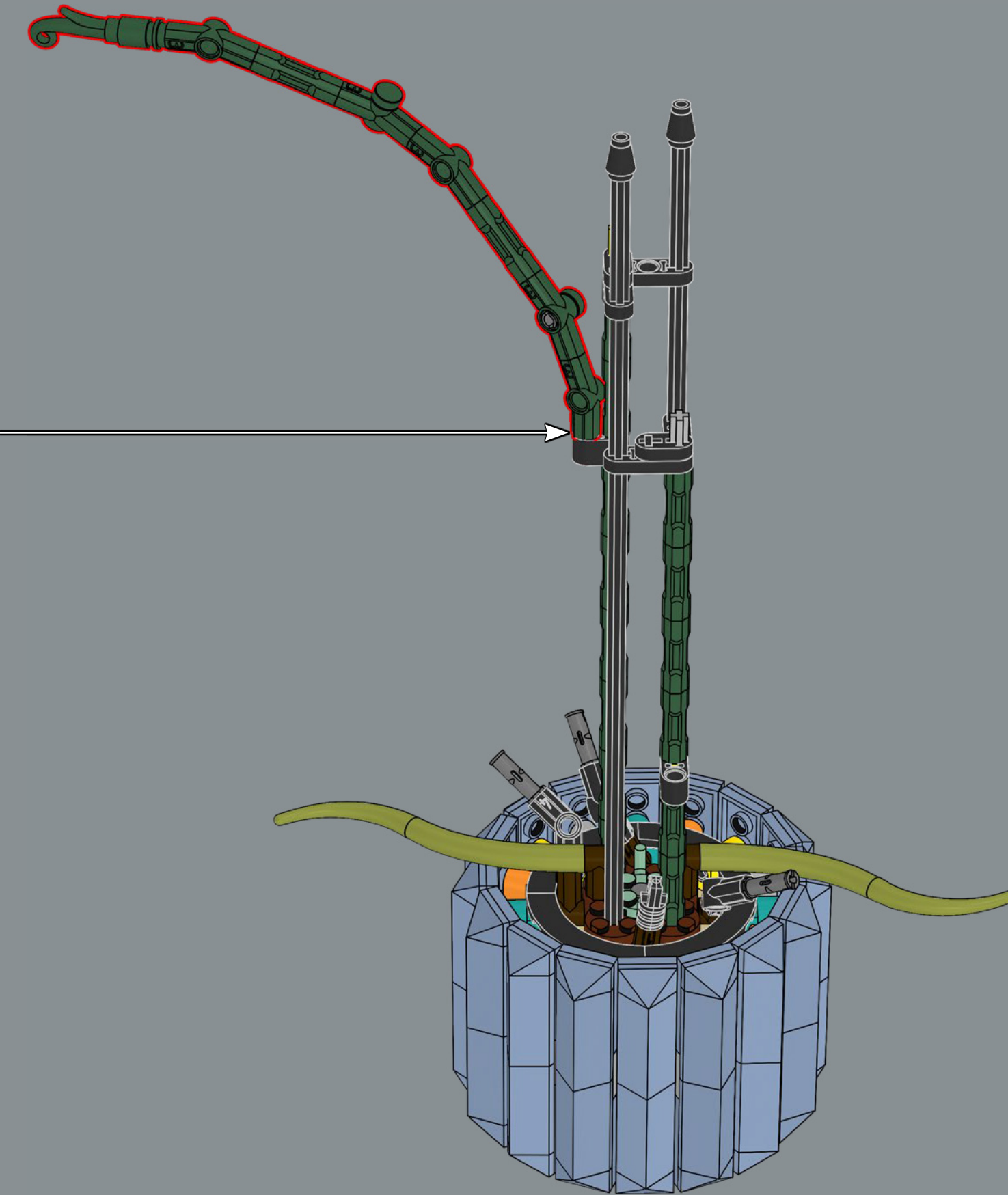

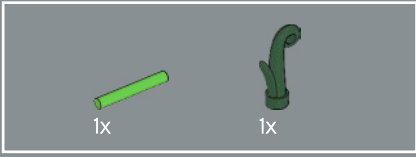
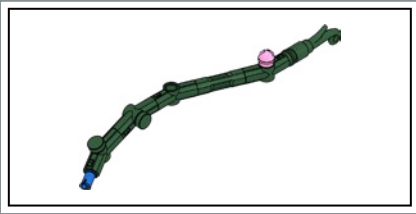

46

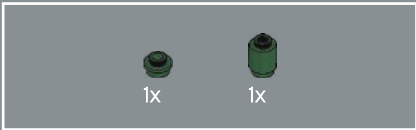
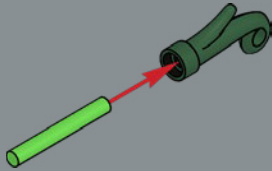

47

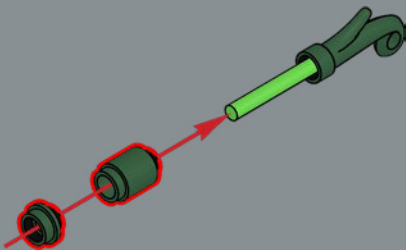

48

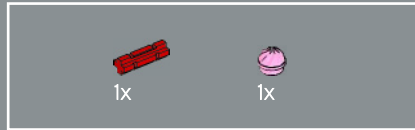
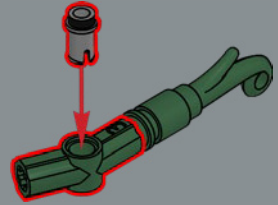

49

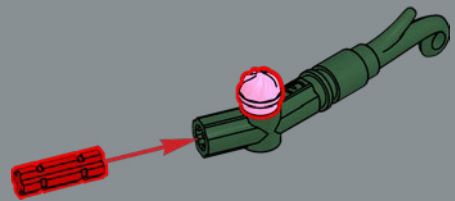

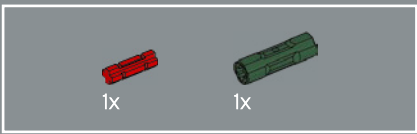

50

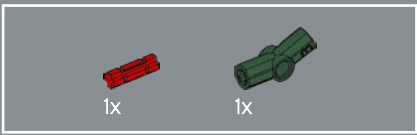
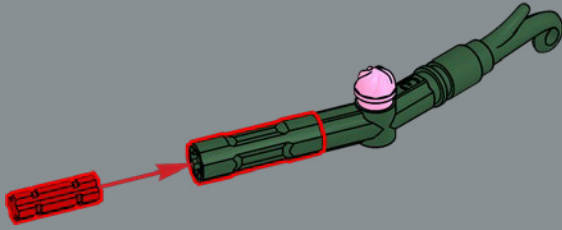

51

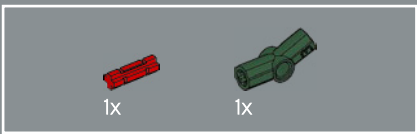
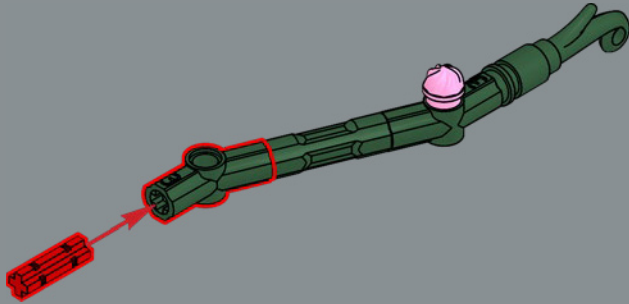

52

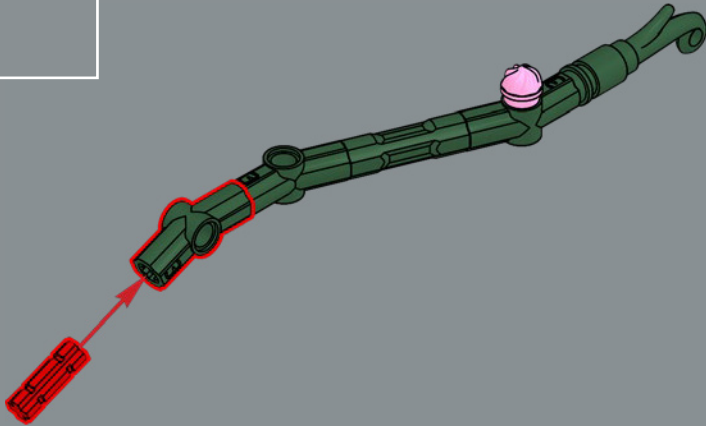

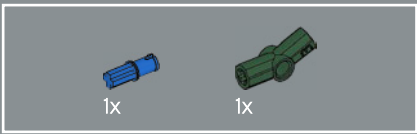

53

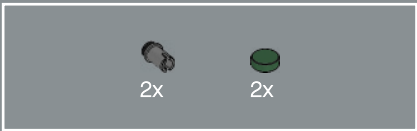
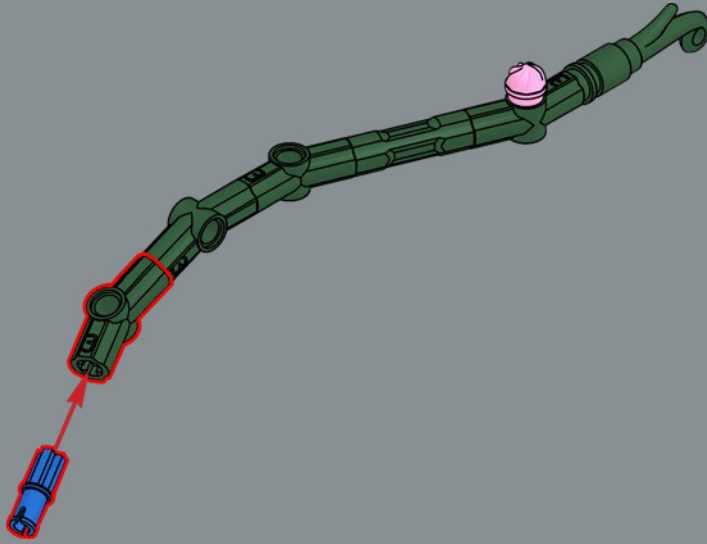

54

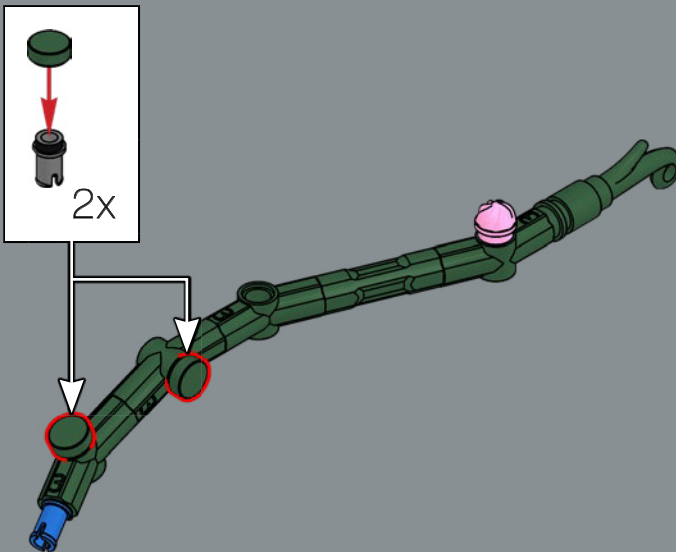



Gli steli dell'orchidea sono costruiti con elementi LEGO® Technic, rendendo la tua orchidea completamente personalizzabile, per farla fiorire tutto l'anno.

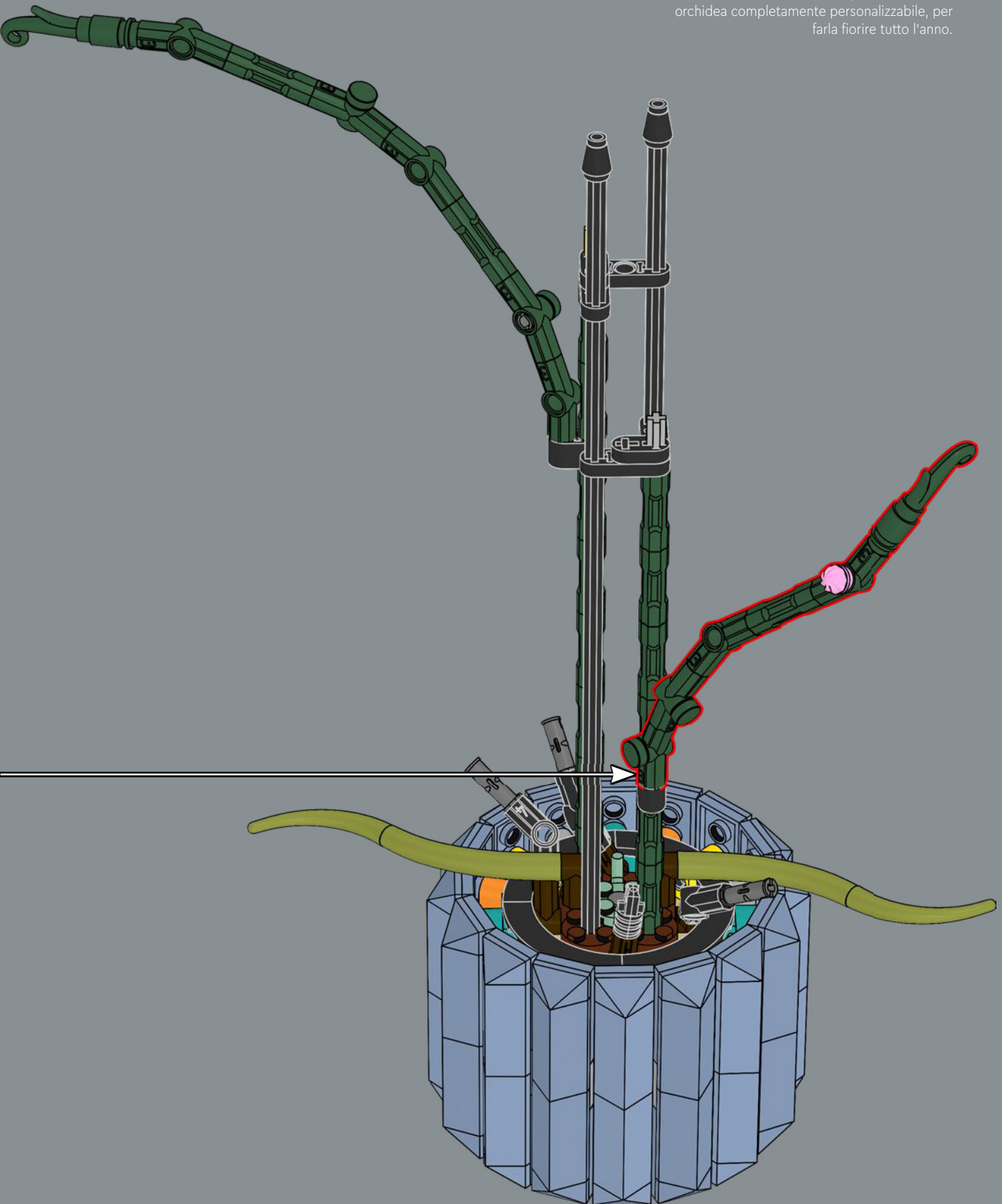



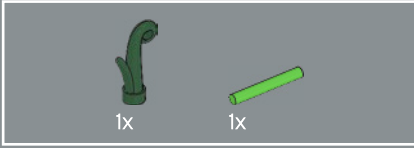
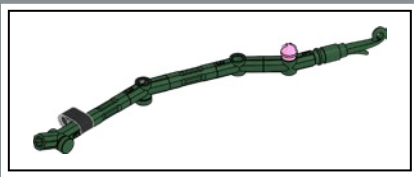

56

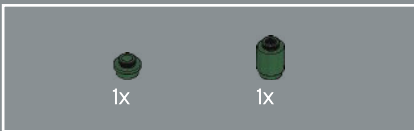
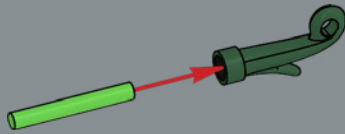

57

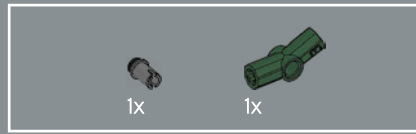
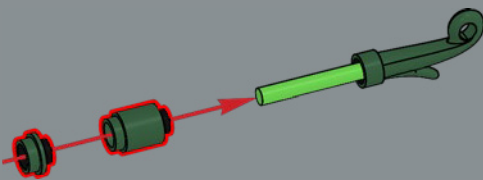

58

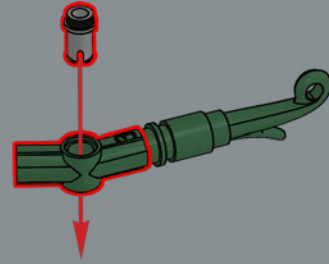

59

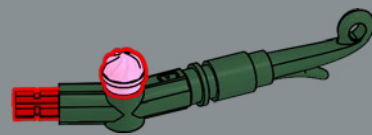

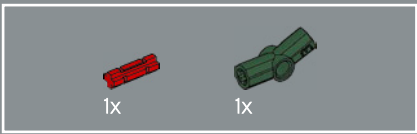

60

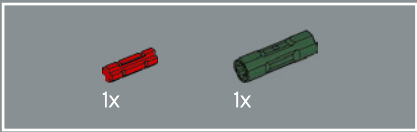
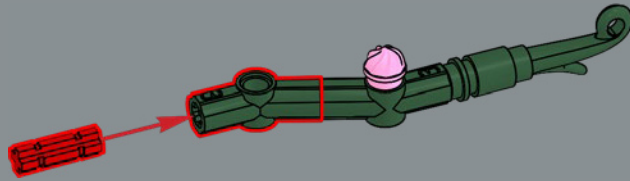

61

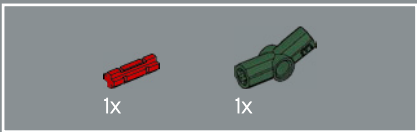
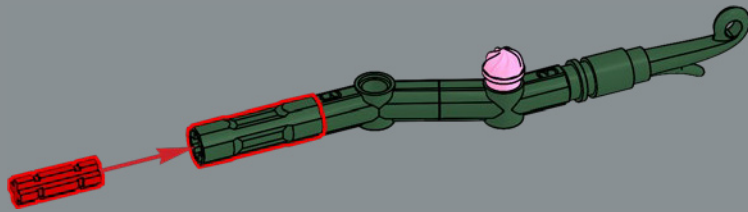

62

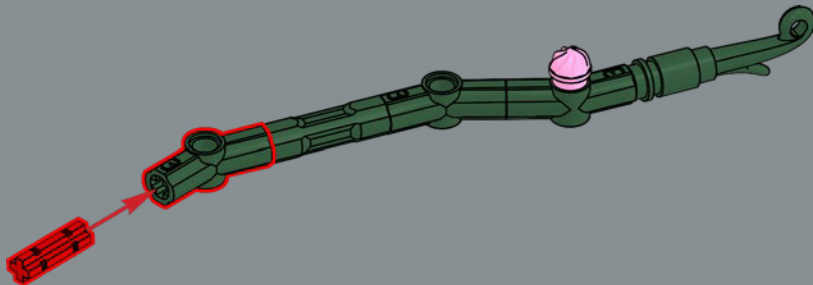

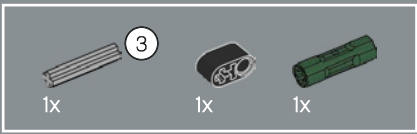

63

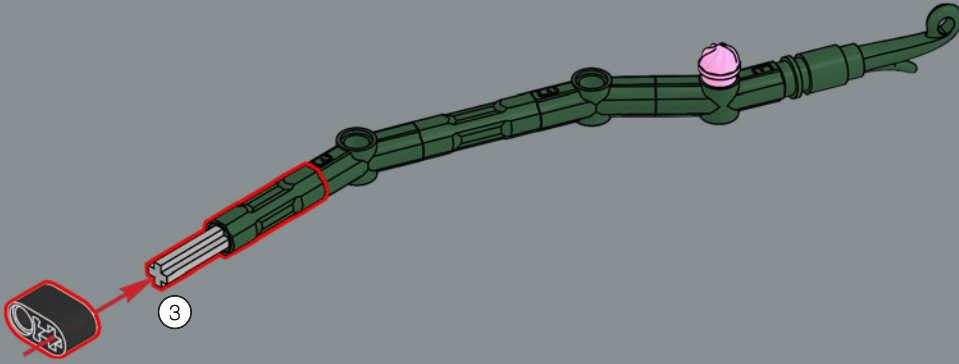

64

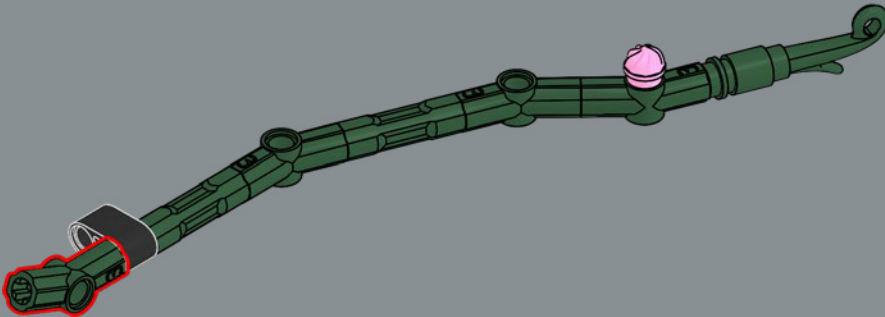

65

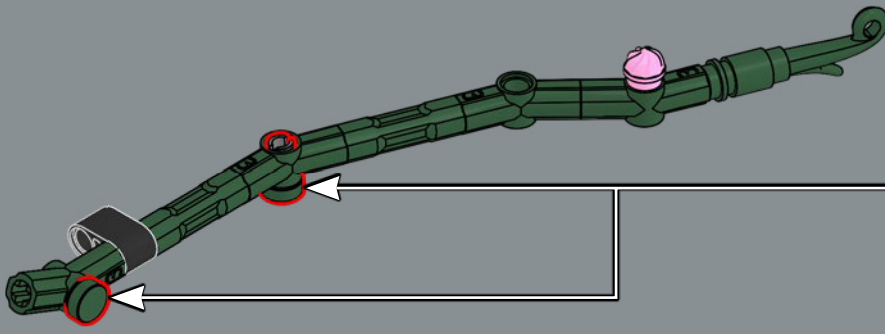

66

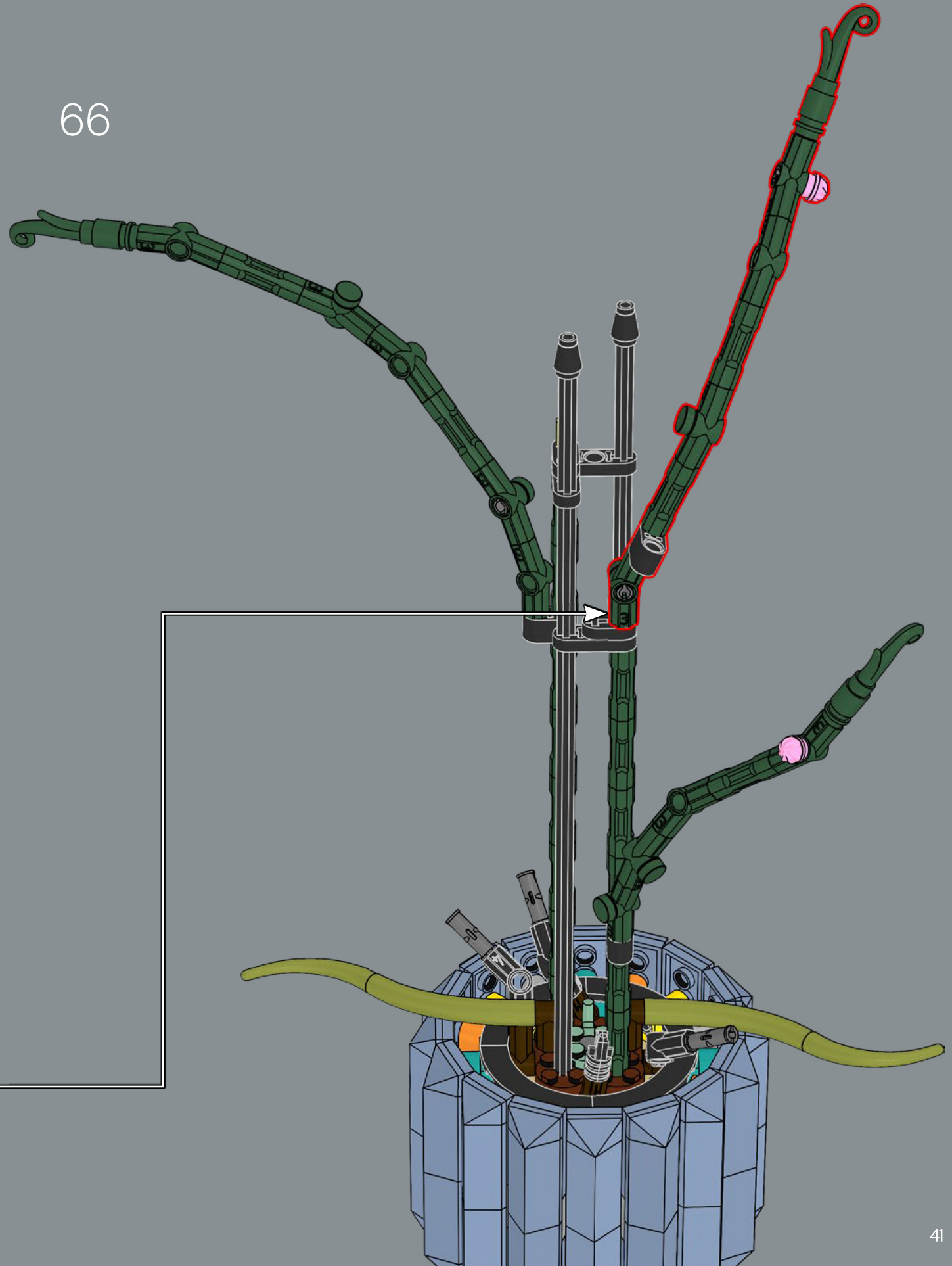

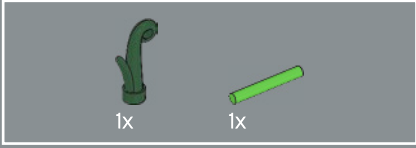
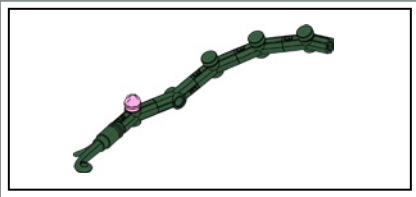

67

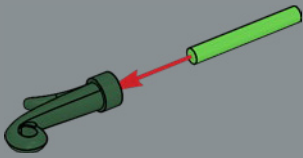

68

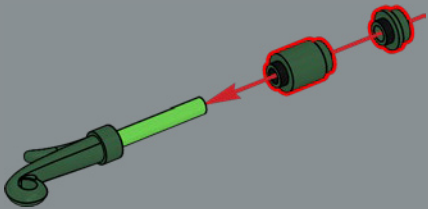

69

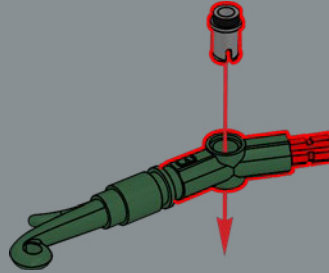

70

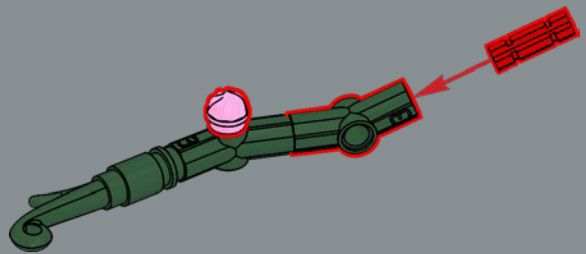



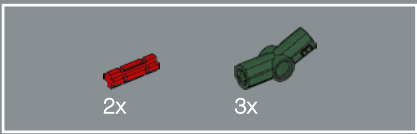

71

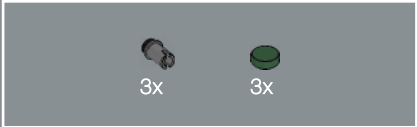
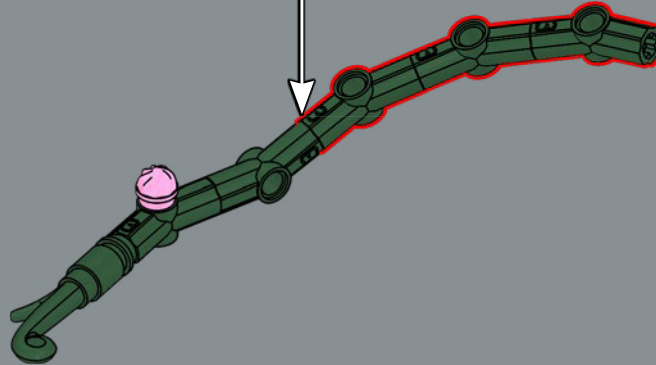
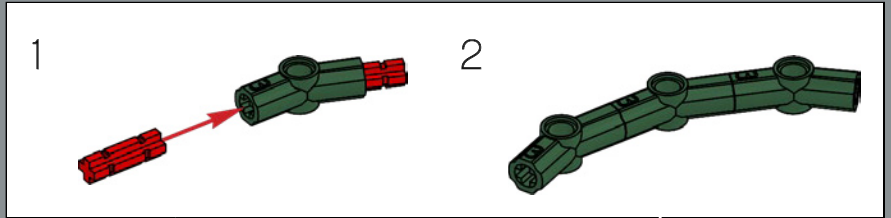

72

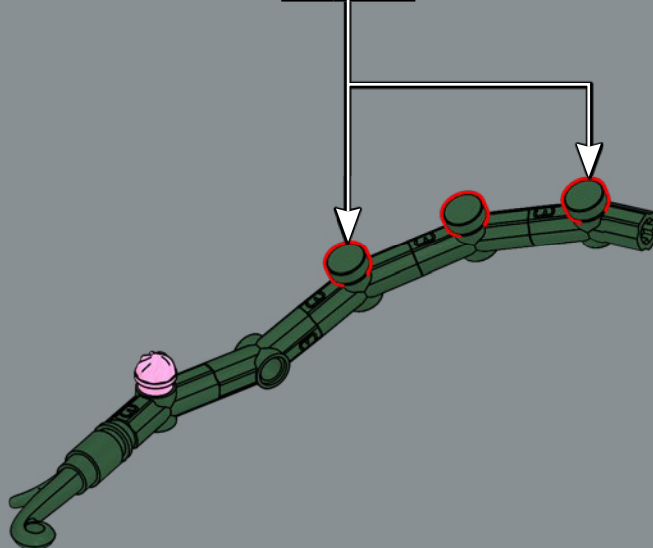
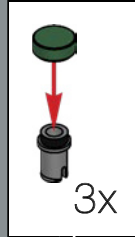

73

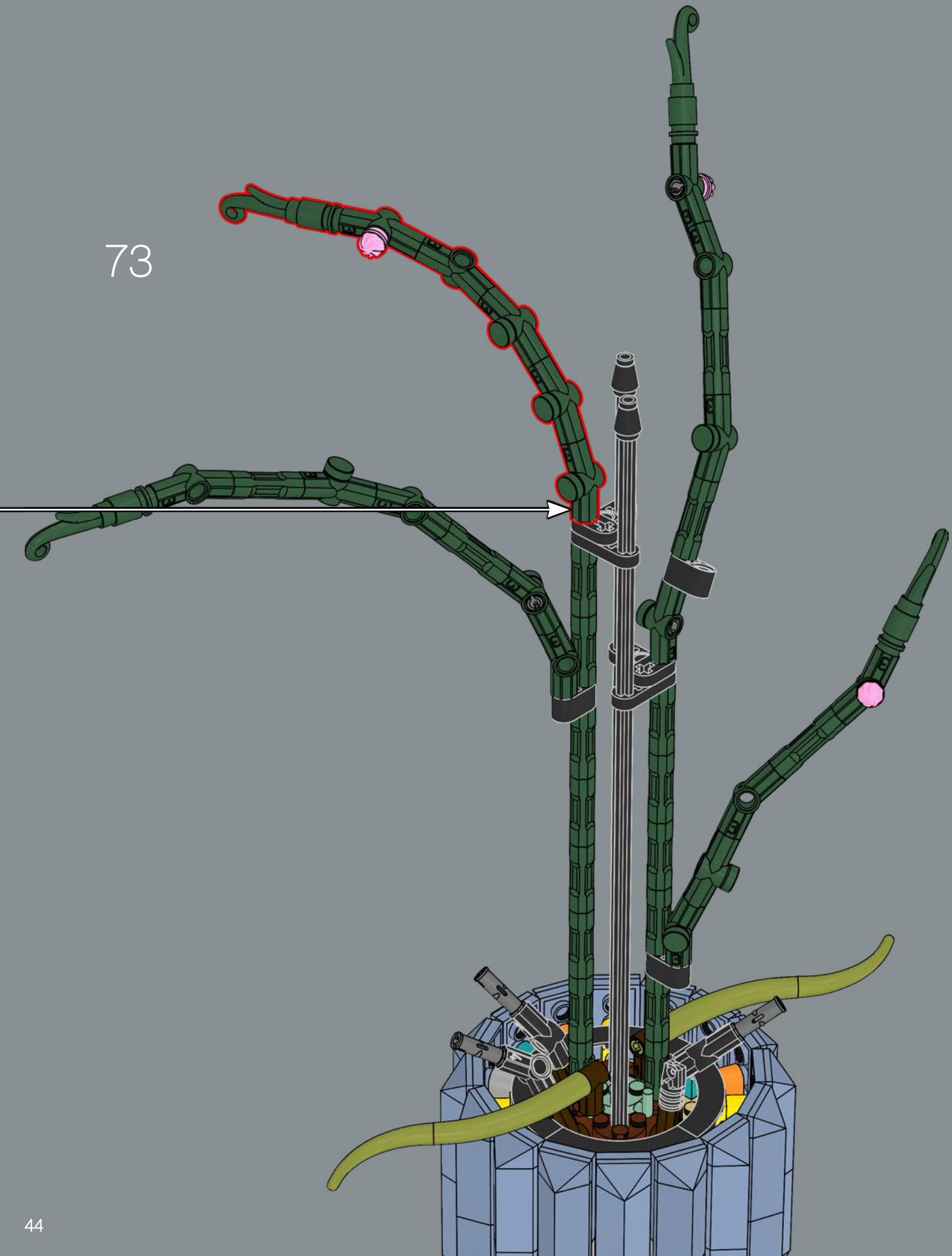

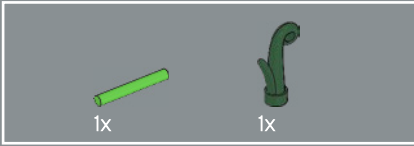
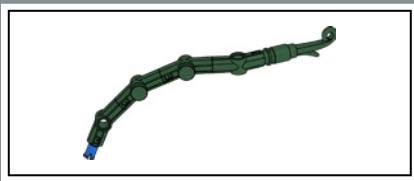

74

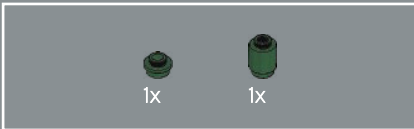
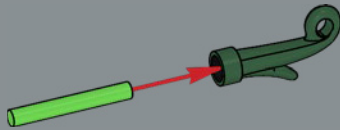

75

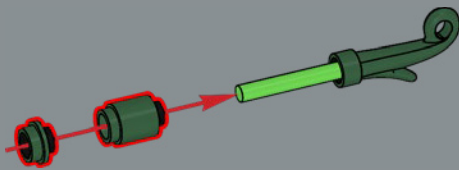

76

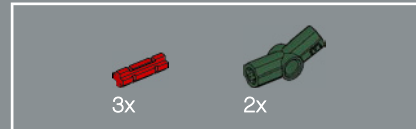
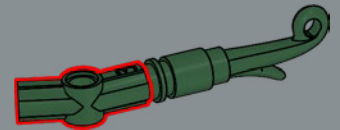

77

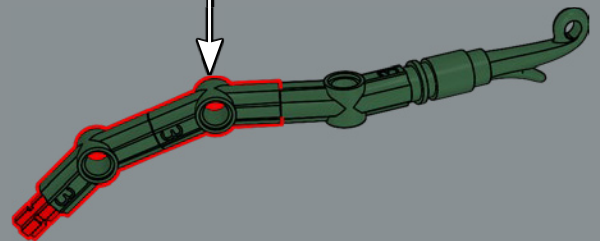
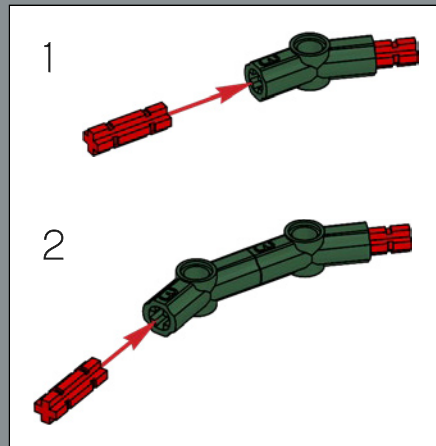

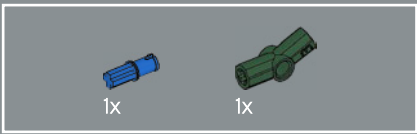

78

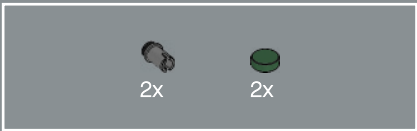
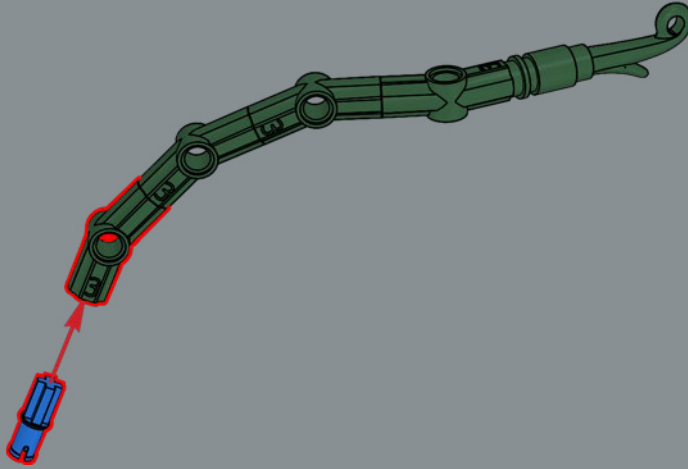

79

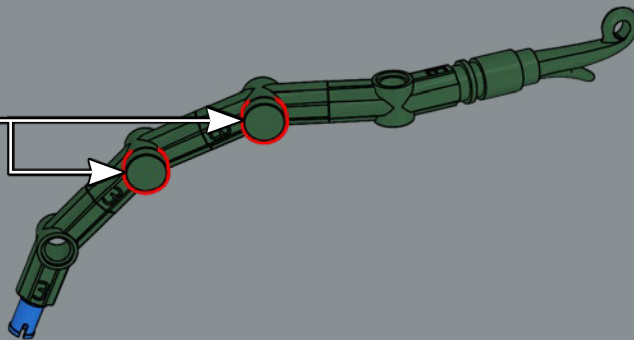
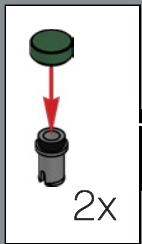

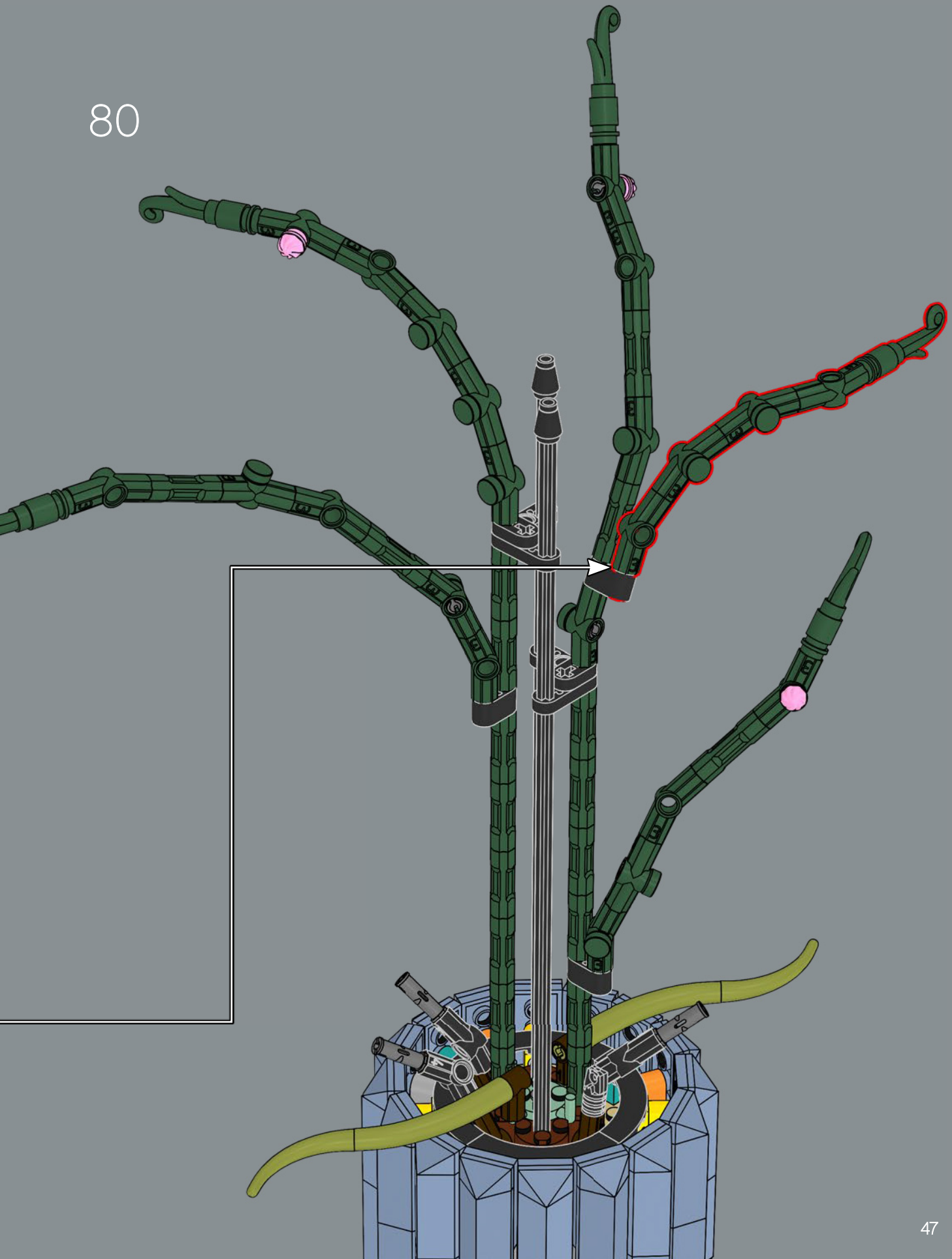





81

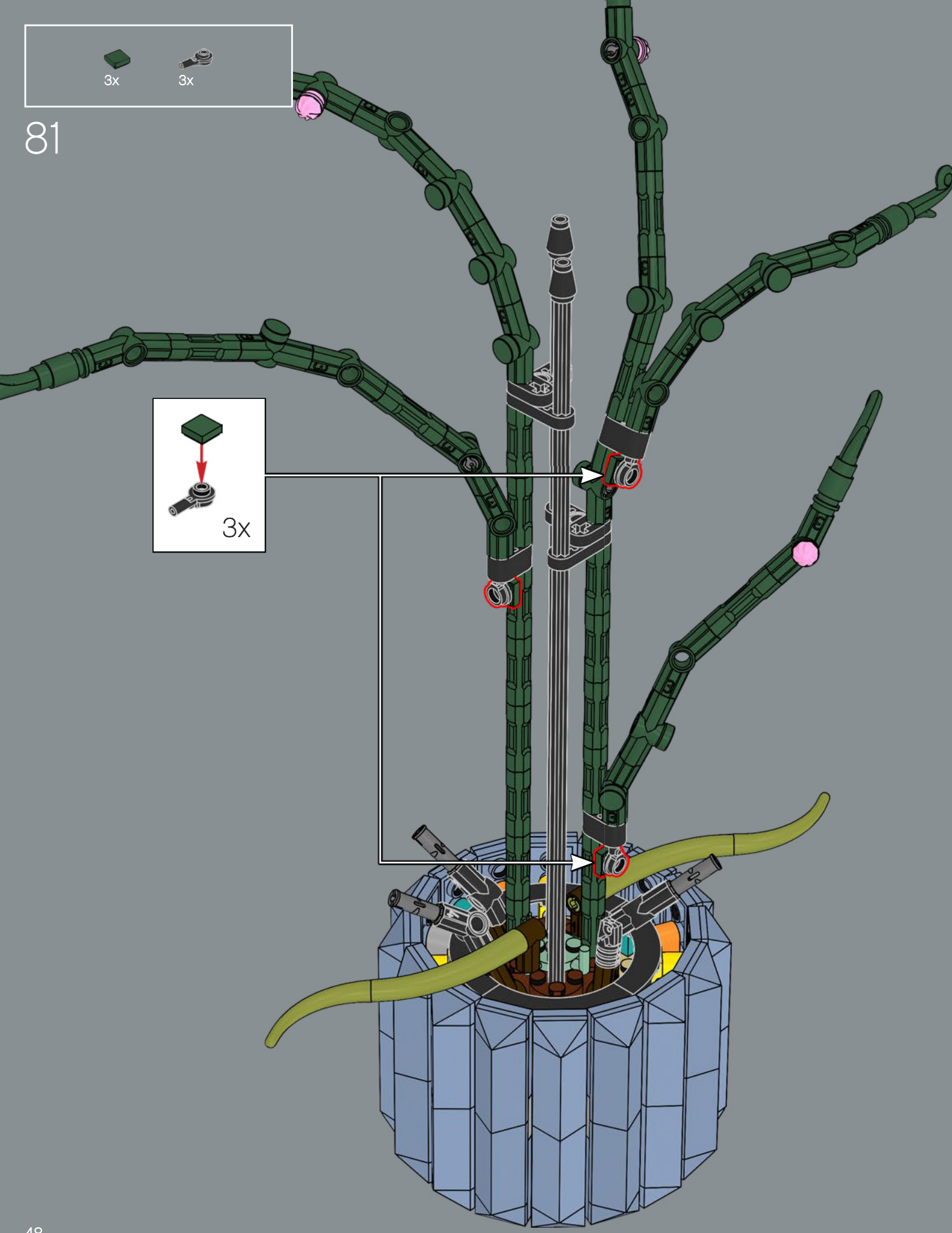
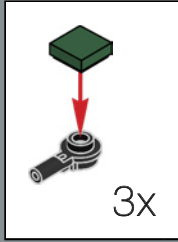

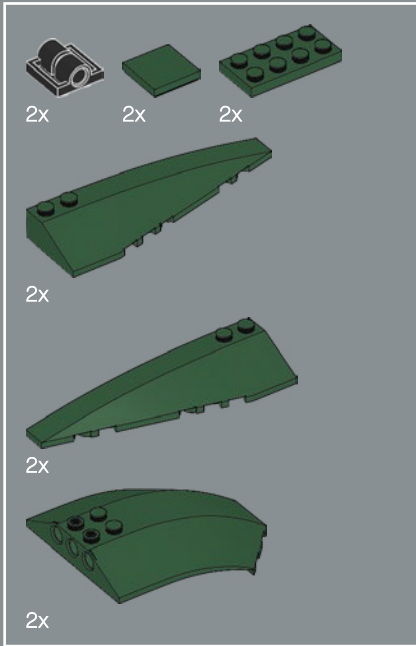
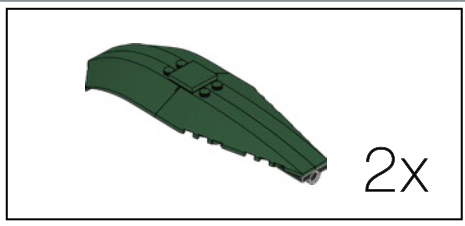

82

1

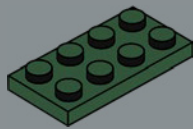

2

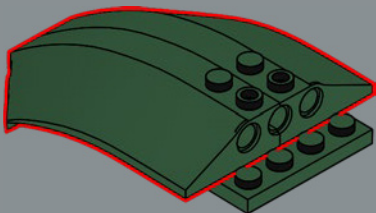

3

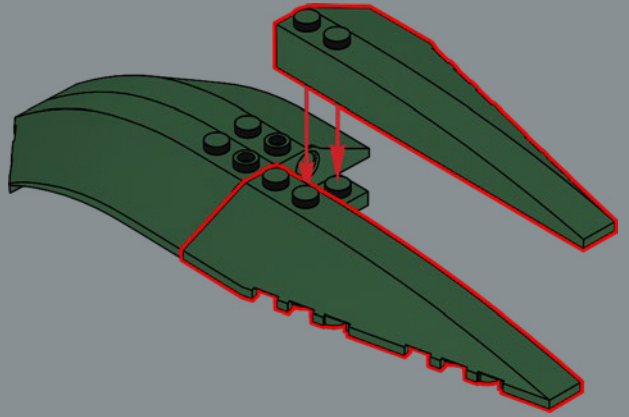

4

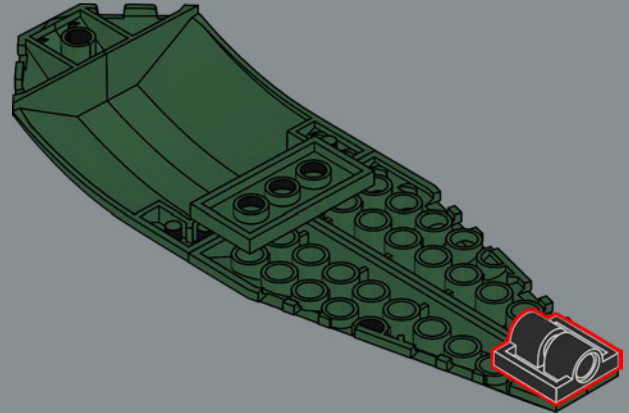

5

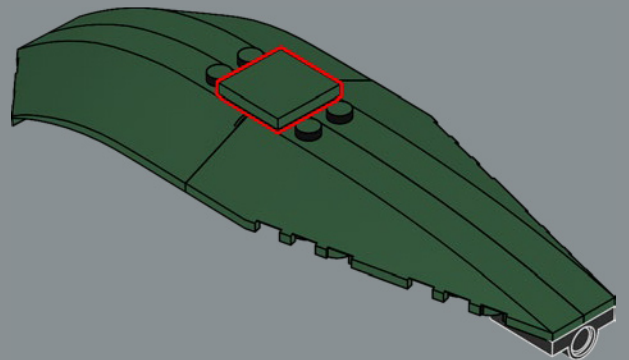

2x

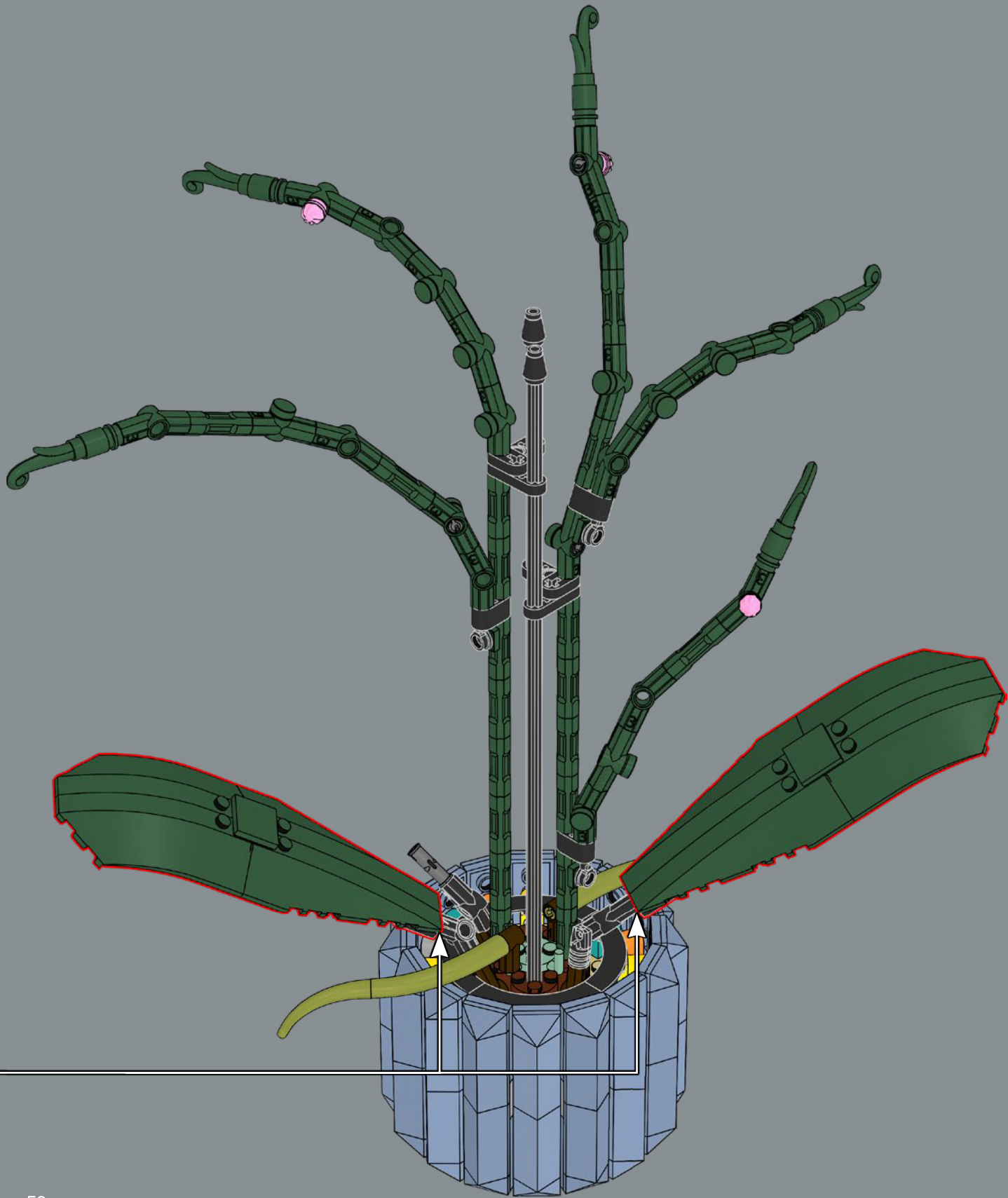

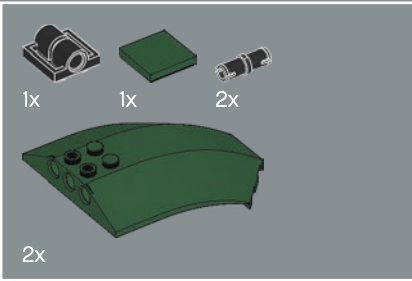
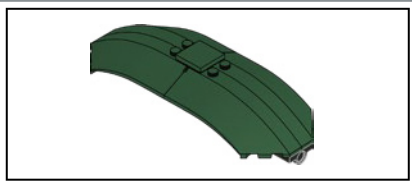

83

1

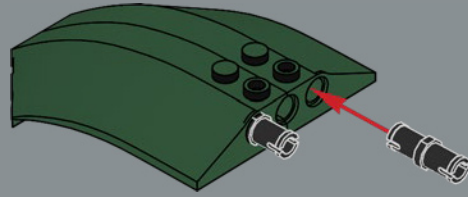

2

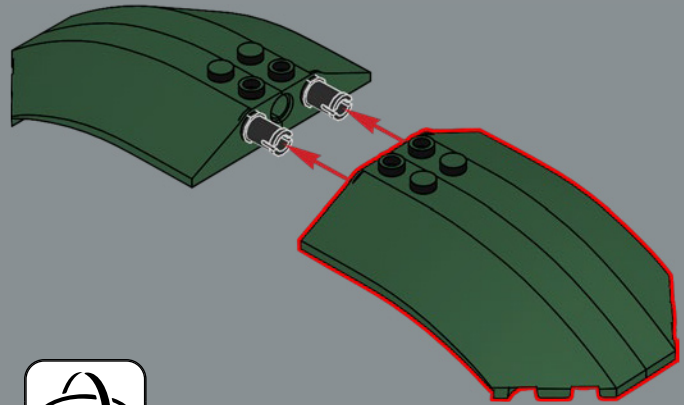

3

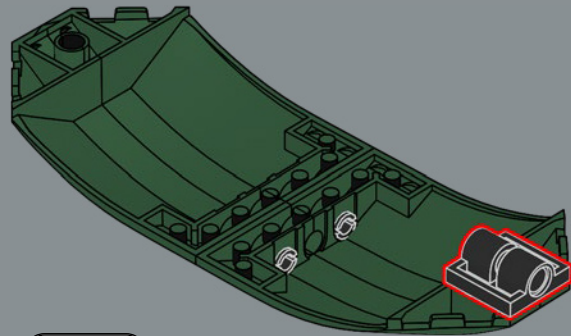

4

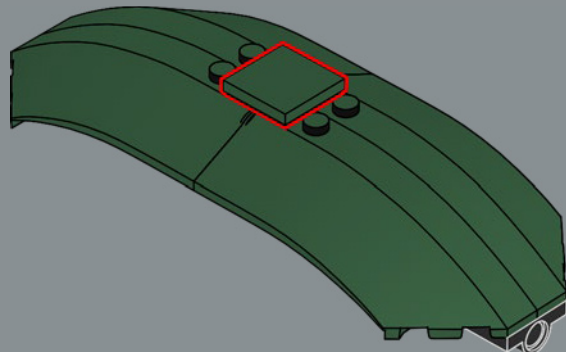



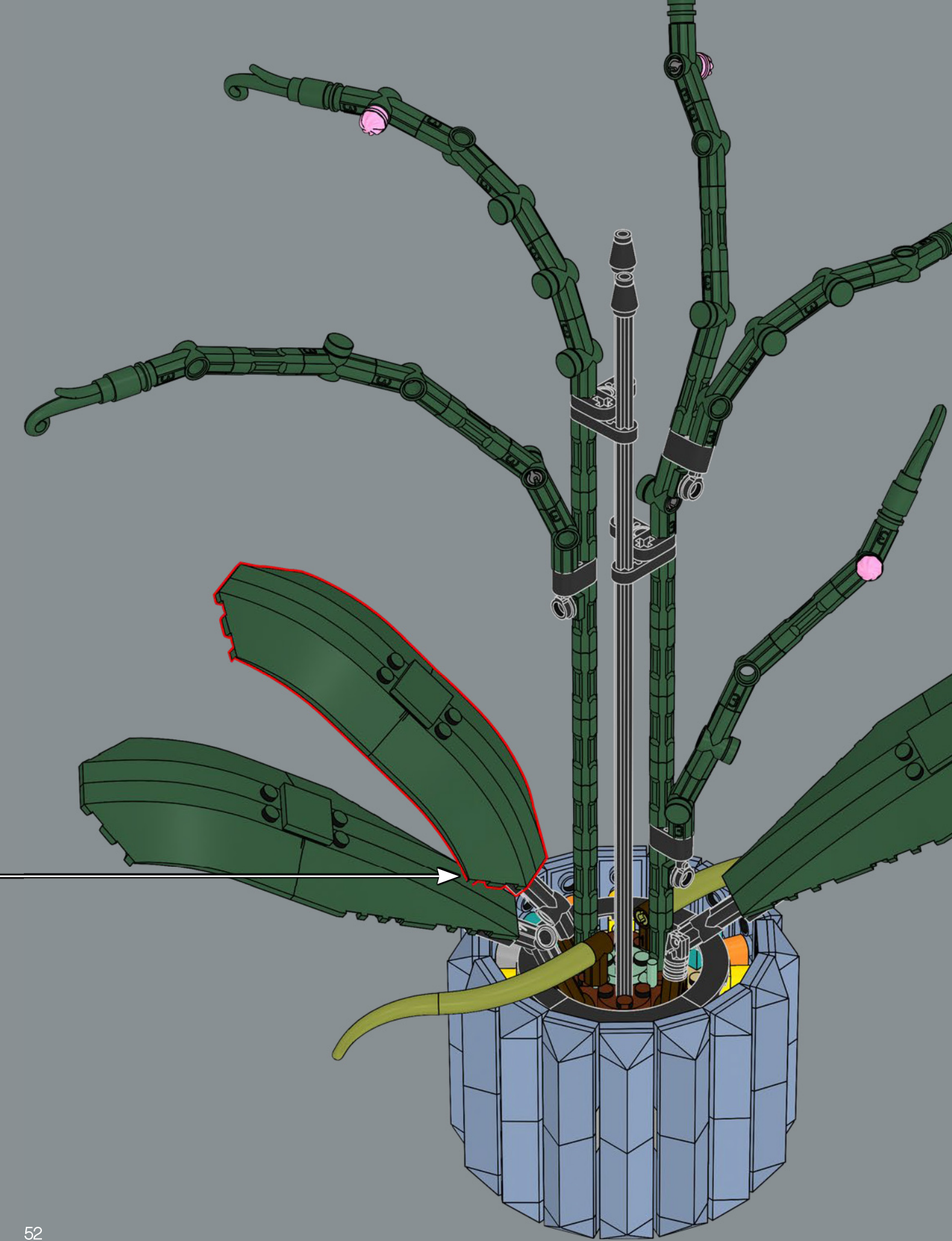



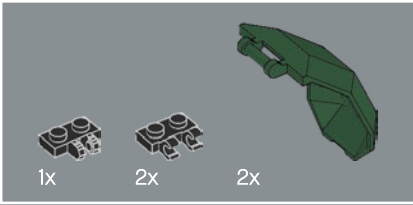

84

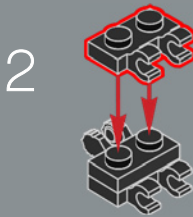
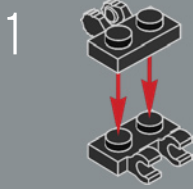

3

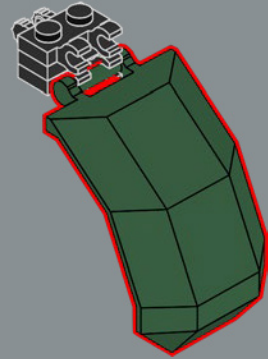

4

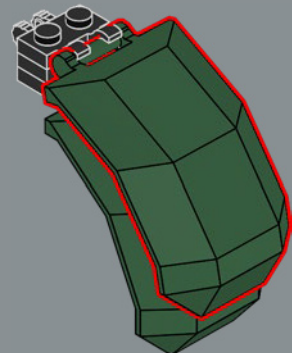

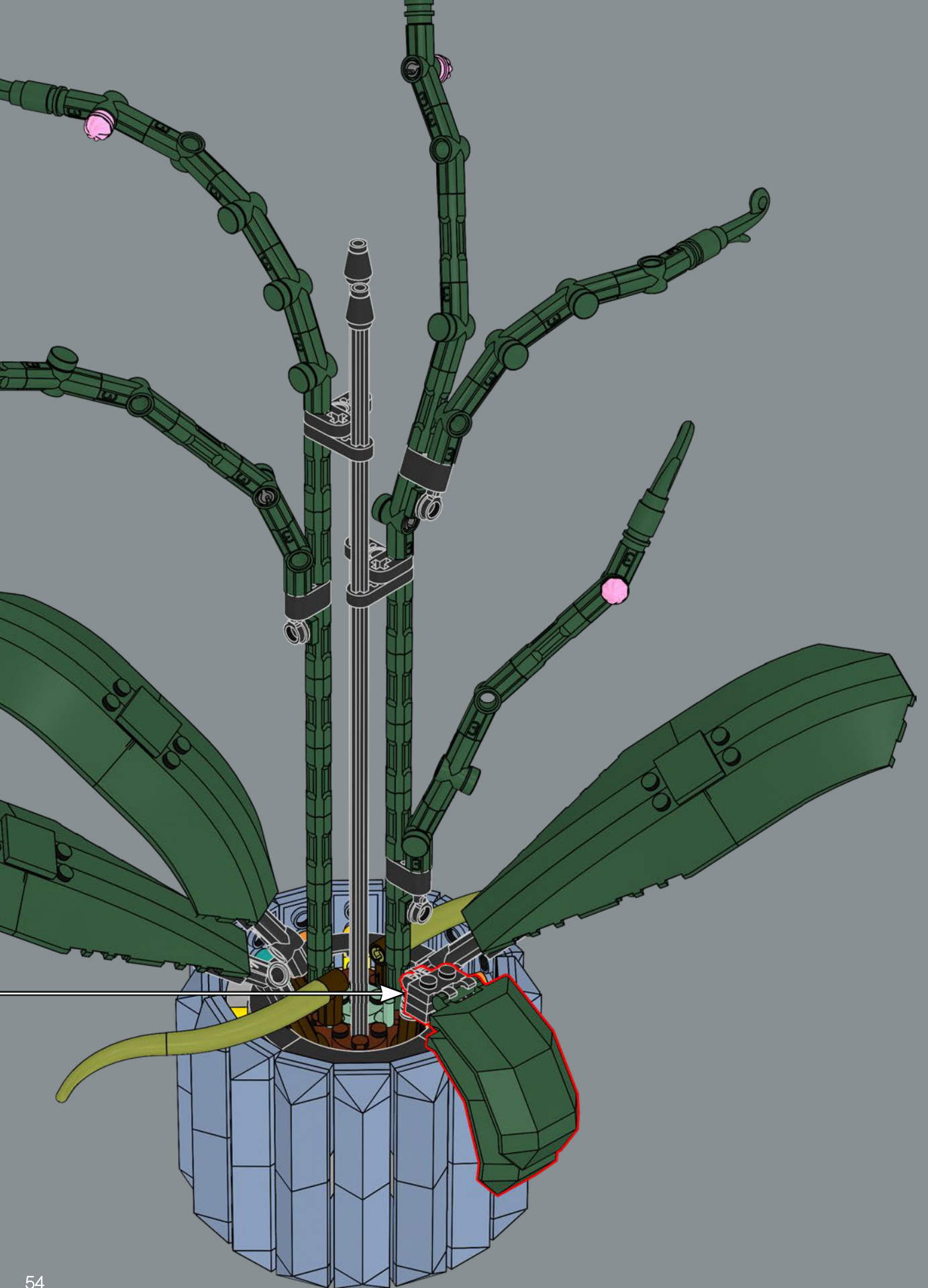



Le teste di Demogorgone del set LEGO®  
Stranger Things sono state usate per  
realizzare i piccoli fiori di questo set.





85

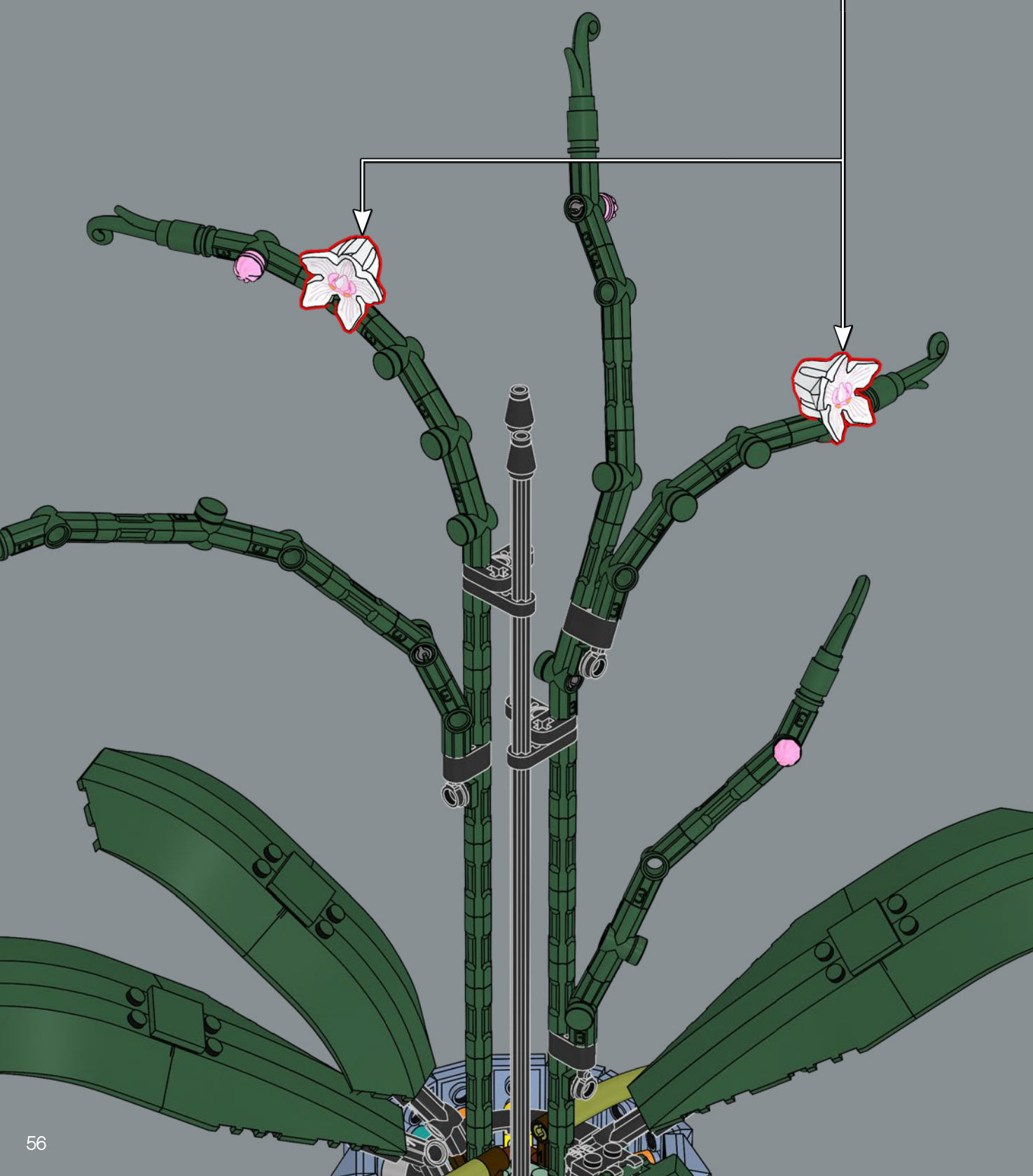
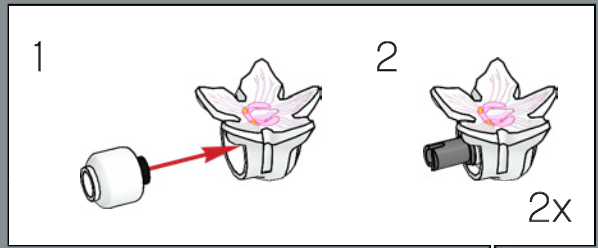

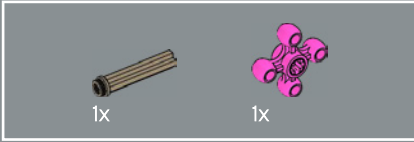

86

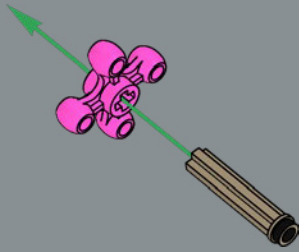

87

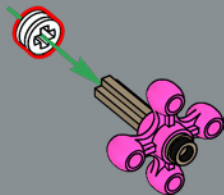

88

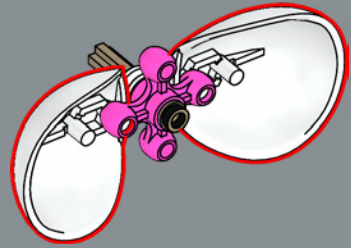

89

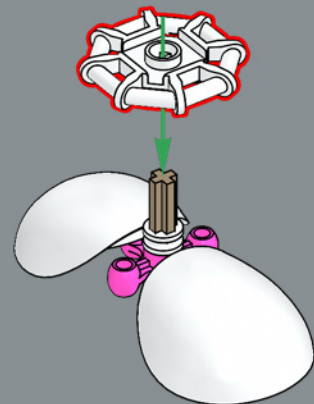

I petali dell'orchidea sono stati costruiti con gli elementi delle spalle dei personaggi LEGO® più grandi.



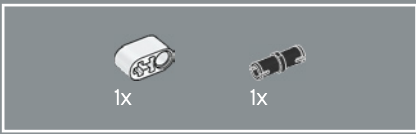

90

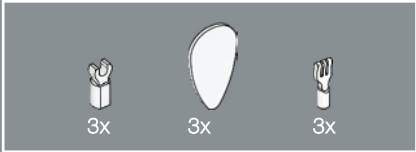
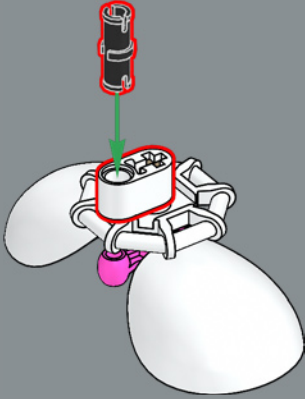

91

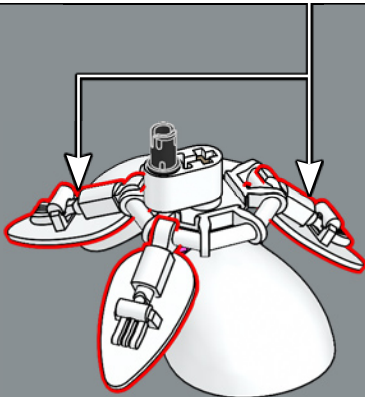
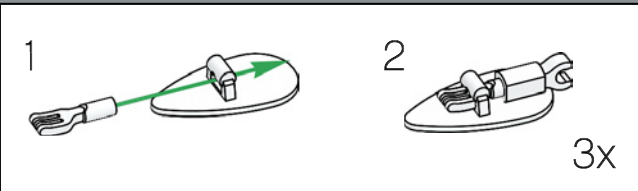

92

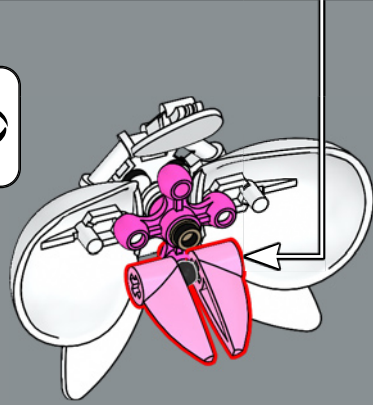
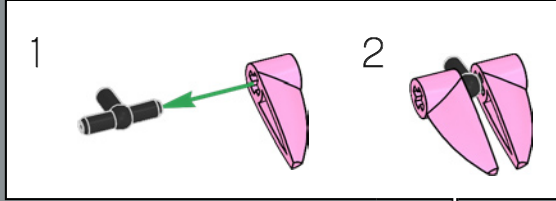

93

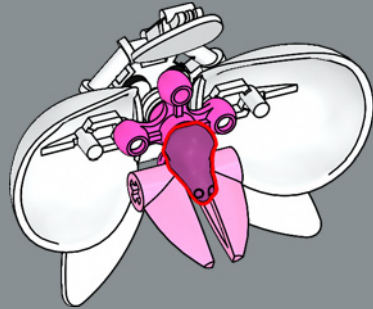

6x



Al centro dei fiori sono presenti elementi rana LEGO®, un omaggio alle rane rosa usate come fiori nel set dell'Albero bonsai LEGO.



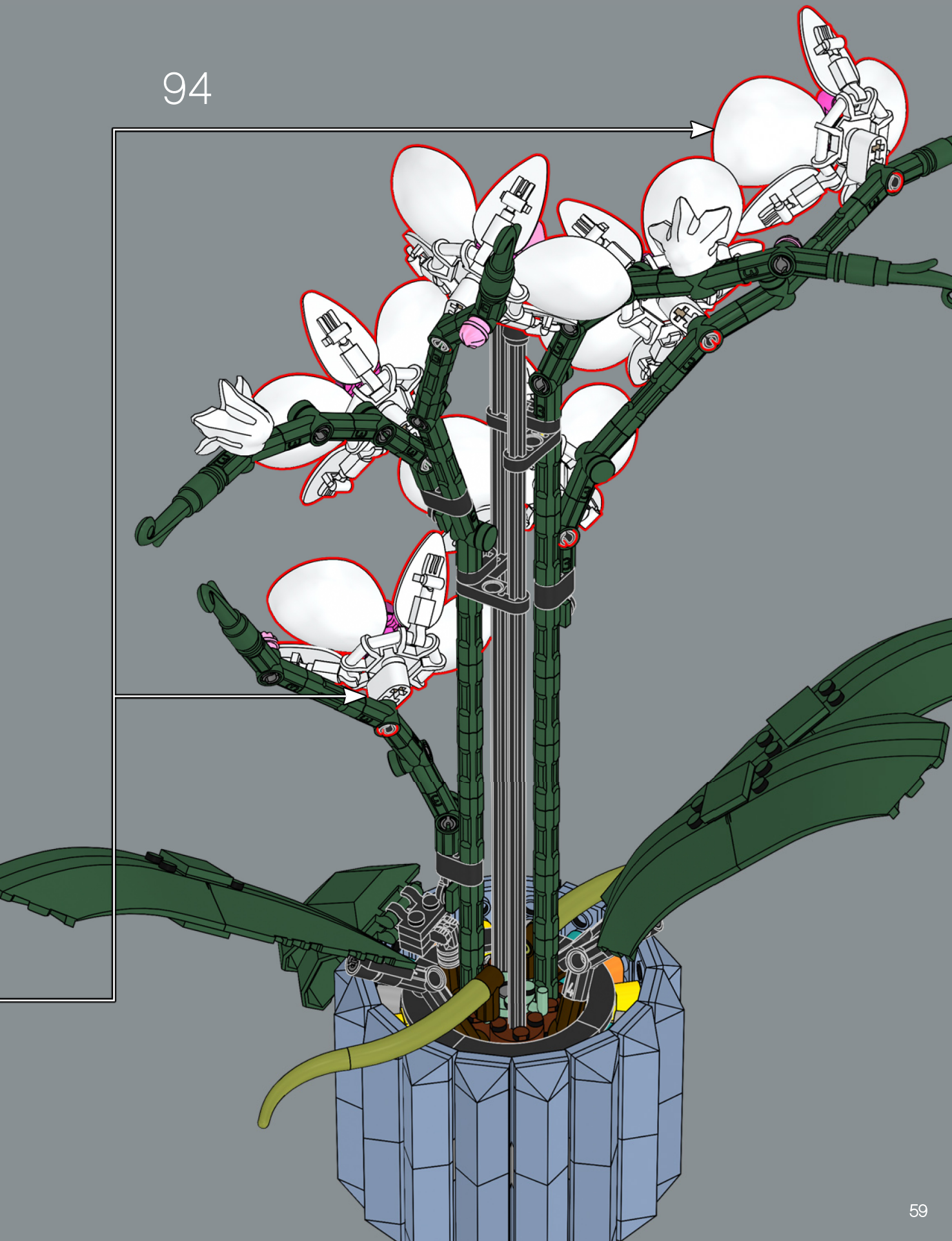

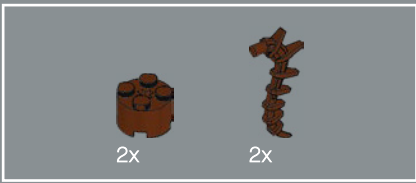

2x

2x

95



Gli scudi delle minifigure originariamente sviluppati per la linea LEGO® Castle del 1995 sono stati usati per i sepali dell'orchidea.



2x

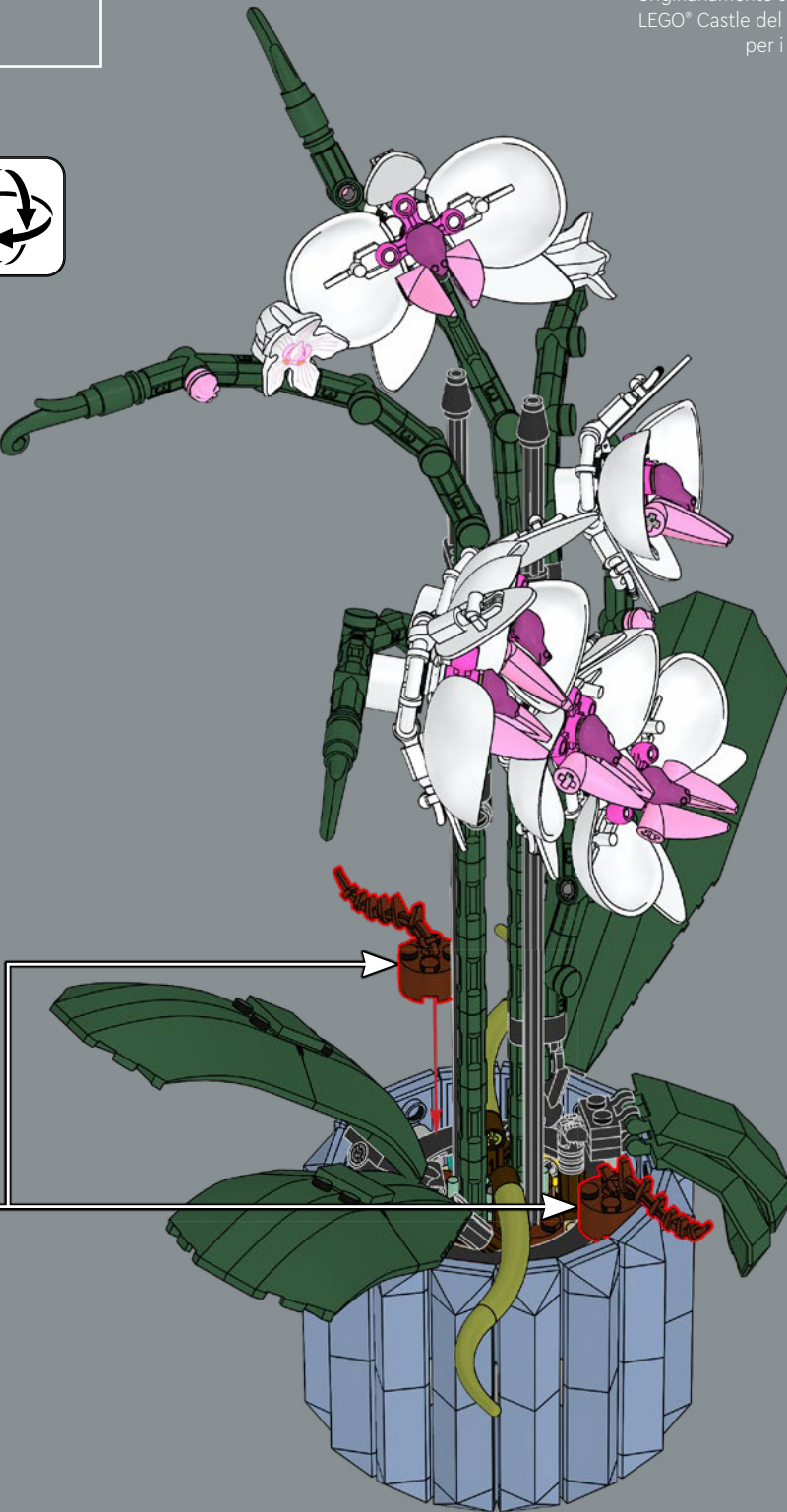



Le orchidee sono spesso messe in vaso con del paccame per agevolare la circolazione dell'aria e il drenaggio, per radici sempre in salute. Qui, il paccame è realizzato con elementi di artiglio dei set LEGO® NEXO KNIGHTS™.



96







1x  
4558956



6x  
6265135



6x  
6009016



8x  
6195358



2x  
362601



2x  
6302214



18x  
6395857



18x  
6395620



12x  
6390377



18x  
6341465



6x  
6360263

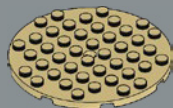

4x  
6378358



3x  
4206482



8x  
6299413



8x  
654124



4x  
4495934



3x  
6130007



2x  
4529236



3x  
6265091



3x  
6196548



1x  
6266207



2x  
6310268



3x  
281726



8x  
6171264



2x  
6338428



2x  
6271810



1x  
6265699



24x  
6279875



3x  
6262897

7

3

7

7



6x  
6104209



2x  
403228



5x  
6161772



8x  
6136553

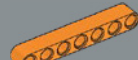

4x  
6339024



2x  
6030521

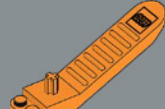

1x  
6240515



8x  
6345402

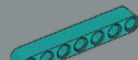

4x  
6323477



8x  
6325515



32x  
6392959



32x  
6395798



32x  
6248957

3.2

6x  
6031821



5x  
6253282

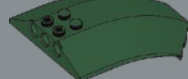

4x  
6392976

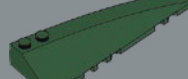

2x  
6392970



2x  
6392971



3x  
6055171



3x  
4528778



2x  
4586057



11x  
6397157



5x  
6230571



5x  
6396754



2x  
6392972



22x  
6344177



19x  
6330196



1x  
6329274



8x  
4211535

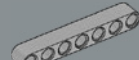

4x  
4495930



16x  
6276848



2x  
4211815

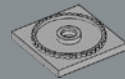

3x  
6045718



16x  
6395635



3x  
6015356

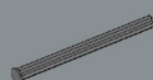

1x  
4499858



6x  
6380668



3x  
6060795



12x  
6395623



2x  
6313597



32x  
6378120



37x  
4142865



6x  
6395622

7

3

8



6x  
4211166



6x  
6075213



2x  
6270052



7x  
6251403



7x  
6353396



6x  
6332586



2x  
6351430



2x  
6351434

32

2x  
6210821



Customer Service

Kundenservice

Service Consommateurs

Servicio Al Consumidor

LEGO.com/service or dial



00800 5346 5555 :



1-800-422-5346 :





# FEEDBACK AND WIN

## FEEDBACK AND WIN

Your feedback will help shape the future development of this product series.

Please visit:

## FEEDBACK UND GEWINNEN

Dein Feedback trägt zur Weiterentwicklung dieser Produktreihe bei.

Geh auf:

## COMMENTEZ ET GAGNEZ

Vos commentaires nous aideront à concevoir les futurs produits de cette gamme.

Rendez-vous sur :

## COMENTA Y GANA

Tu opinión nos ayudará a dar forma al desarrollo de esta serie de productos en el futuro.

Visita:

## 反馈有奖

您的反馈将有助于我们在今后改进本系列产品。

请访问：

[LEGO.com/productfeedback](https://www.lego.com/productfeedback)

By completing, you will automatically enter a drawing to win a LEGO® set.

Terms & Conditions apply.

Durch Ausfüllen nimmst du automatisch an der Verlosung eines LEGO® Preises teil.

Es gelten die Teilnahmebedingungen.

En envoyant vos commentaires, vous serez automatiquement inscrit(e) à un tirage au sort qui vous permettra de remporter un prix LEGO®.

Offre soumise à conditions.

Al contestar, participarás automáticamente en el sorteo y podrás ganar un set LEGO®.

Sujeto a Términos y Condiciones.

完成我们的反馈调查，即可自动进入抽奖环节，赢取乐高® 套装。

适用《条款和条件》。

